

veterinary technology for life

**Eickemeyer**<sup>®</sup>

# Veterinary Orthopaedic Catalogue

*pro*  
*veterinary experts*



# Content

Editorial.....	4
<b>1 EickLoxx Small Osteosynthesis System .....</b>	<b>5</b>
Components.....	6
Characteristics.....	7
Item List.....	8
Specialist Article .....	9
Case Reports .....	13
Video .....	19
<b>2 EickLoxx Large Osteosynthesis System.....</b>	<b>21</b>
Components and Characteristics.....	22
Item List.....	23
<b>3 UFEG® – External Skeletal Fixation System .....</b>	<b>25</b>
Components.....	26
Characteristics.....	27
Item List.....	28
Specialist Article .....	28
<b>4 CBS System – Compression Bone Screw System.....</b>	<b>29</b>
Components and Characteristics.....	30
Indications and Surgical Technique .....	31
Basic Instrumentation Set – Item List .....	32
Set for Toy Breed Dogs and Cats – Item List.....	33
Set for Small Dogs – Item List.....	34
Set for Medium Sized Dogs – Item List.....	35
Set for Large Dogs – Item List .....	36
Case Reports .....	37
<b>5 EICKEMEYER® PinCube, PinPositioner and Pins .....</b>	<b>41</b>
EICKEMEYER® PinCube – Characteristics.....	42
EICKEMEYER® PinPositioner Set– Characteristics and Item List.....	43
K-Wires, STEINMANN Pins and Tools – Item List .....	44
EICKEMEYER® PinCube – Case Report .....	45
EICKEMEYER® PinCube, PinPositioner and Pins – Specialist Article .....	46
<b>6 MTV – Minimally Invasive Transilial Vertebral Blocking.....</b>	<b>51</b>
Characteristics.....	52
Surgical Technique .....	53
Item List.....	54
Specialist Article .....	55
Videos.....	60

<b>7.1</b>	<b>Cruciate Ligament Surgery – Extracapsular Cranial Cruciate Stabilisation</b>	<b>61</b>
	Characteristics	62
	Item List	63
<b>7.2</b>	<b>Cruciate Ligament Surgery – TTA Classic Set</b>	<b>67</b>
	Components	68
	Item List	69
<b>7.3</b>	<b>Cruciate Ligament Surgery – TPLO</b>	<b>71</b>
	<b>EickLoxx TPLO Osteosynthesis System</b>	<b>72</b>
	Components	72
	Characteristics	73
	Item List	74
	<b>TPLO Saw Jig and Cannulated Saw Blade Set</b>	<b>76</b>
	Components and Characteristics	76
	Item List	77
	Case Report	78
	Rotation Chart	83
	<b>TPLO non-cannulated Saw Blades</b>	<b>84</b>
	Characteristics and Item List	84
<b>7.4</b>	<b>Cruciate Ligament Surgery – Zlig Intra-Articular Cruciate Ligament Replacement</b>	<b>85</b>
	Components	86
	Reference Chart	88
	Item List	89
	Case Report	90
	Videos	100
<b>8</b>	<b>EickLoxx SPP® Patellar Luxation System</b>	<b>101</b>
	Components and Characteristics	102
	Surgical Technique	103
	Item List	106
	Specialist Article	107
	Video	111
<b>9</b>	<b>3M™ IOBAN™ 2 Incision Drapes</b>	<b>113</b>
	Components and Characteristics	114
	Application	115
<b>10</b>	<b>OrthoVet PLUS Battery Powered Drill System</b>	<b>117</b>
	Components	118
	Characteristics	119
	Item List	120
<b>11</b>	<b>OrthoVet TPLO Battery Powered Saw</b>	<b>121</b>
	Components and Characteristics	122
	Item List	123

# ORTHOPAEDIC TECHNOLOGY FOR LIFE

*Dear Veterinary Surgeon,*

We are pleased to present our latest orthopaedic catalogue. The implants and systems presented here are tailored to the most common orthopaedic interventions in small animals – especially in dogs and cats.

Close cooperation with leading small animal surgeons and innovative R&D companies has enabled us to provide practical and application-oriented solutions.

All products are made from carefully selected raw materials predominantly in Germany. In this way, we ensure that high-quality products are created, with components precisely matched to one another in terms of fit.

We impart the necessary knowledge, for the application of our products, in practical seminars in our advanced training centres in Germany, Denmark and the UK. These events, led by experienced veterinarians, cover a broad spectrum, from simple fracture treatment to complex orthopaedic procedures. Covering both the theory and the practical, we combine the evidence-based science with pioneering innovations.

The welfare of animals is always the focus of our activities. We aim to find solutions to the issues that you encounter. So if you have a problem, please contact us – maybe we can find a solution together.

For EICKEMEYER®, “Veterinary Technology for Life” means the continuous adaptation to the requirements of orthopaedic veterinary surgery, as well as a permanent development program to be able to master orthopaedic challenges even better in the future.

# EickLoxx Small

A universal osteosynthesis system for small animals  
up to 15 kg

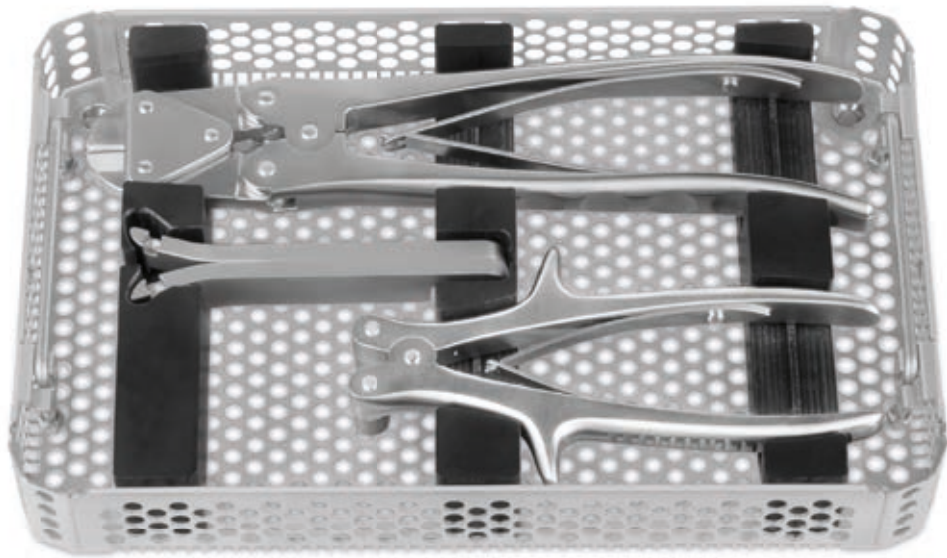

# EICKLOXX SMALL OSTEOSYNTHESIS SYSTEM – COMPONENTS

The EickLoxx Small is a polyaxial locking kit for dogs and cats up to 15 kg. The system distinguishes itself through the polyaxial placement of the custom-fit screws, combining the advantages of a locking plate system with polyaxial screw placement in  $\pm 15^\circ$  longitudinal and transverse pivoting.

Compared to conventional osteosynthesis systems, the use of internal fixation locking systems such as the EickLoxx Small facilitates faster healing of fractures and improved implant strength. It is for this reason that the removal of plates and screws is rarely indicated.

The biocompatible titanium plates are available in three sizes, can be cut to the desired length and be bent in three planes. Specially designed tools are included to perform this. Titanium also reduces artefacts in post-operative imaging.

EickLoxx Small is a modular system. All implants and instruments are made in Germany using only the highest quality raw materials.

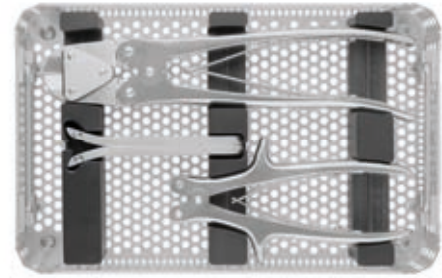

185500

## Titanium EickLoxx Small Bone Plates

- ▶ Bendable, cuttable, twistable
- ▶ Multidirectional locking
- ▶ 46 hole Bone Plate, 230 mm x 5.0 mm x 2.0 mm, System 1.7 / 2.3
- ▶ 41 hole Bone Plate, 225 mm x 6.5 mm x 2.4 mm, System 1.7 / 2.3
- ▶ 28 hole Bone Plate, 224 mm x 8.0 mm x 2.7 mm, System 2.7 / 3.5

### 185518 – 185520

## Titanium Locking Screws

- ▶ Self-drilling, self-tapping
- ▶ 28 Titanium Locking Screw  $\varnothing$  1.7 mm, silver, length: 8 – 20 mm
- ▶ 28 Titanium Locking Screw  $\varnothing$  2.3 mm, gold, length: 8 – 20 mm,
- ▶ 44 Titanium Locking Screw  $\varnothing$  2.7 mm, light blue, length: 10 – 30 mm

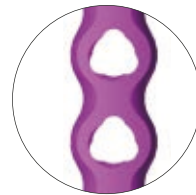

185518  
Top view



185518  
Cross-section



185518  
Bottom view

The geometry of the screw head and screw enables polyaxial placement with the Drill Guide System in  $\pm 15^\circ$  longitudinal and transverse pivoting.

### 185521 – 185545

The 46 / 41-hole bone plates can be locked with, or a combination of, 1.7 mm and 2.3 mm screws. The 28-hole bone plate can be locked with either 2.7 mm or 3.5 mm screws from the EickLoxx Large or the EickLoxx TPLO system.



185525



185532



185538



# EICKLOXX SMALL OSTEOSYNTHESIS SYSTEM – CHARACTERISTICS

- ▶ EickLoxx Small bone plates minimise contact with the periosteum. This reduces the iatrogenic load on the bone perfusion common in conventional compression plates.
- ▶ Preservation of the bone perfusion significantly reduces the risk of infection and accelerates bone healing
- ▶ The risk of infection is further reduced through the biocompatibility of titanium and the absence of fretting



Fig. 1



Fig. 2

## Illustrations

- ▶ Polyaxial placement with Drill Guide Funnel System in  $\pm 15^\circ$  longitudinal and transverse pivoting (Fig. 1)
  - ▶ 1.7 mm or 2.3 mm screws, combinable (Fig. 2)
  - ▶ Use a core drill to drill hole. Plates can be bent in three planes (Fig. 3 and 4)
  - ▶ Plate Bending Pliers with rollers (Fig. 5 and 6)
  - ▶ Attention! Please avoid reverse bending of the plates (Fig. 7 and 8).
- Always bend plates in a slow and steady motion.  
Jerky movements are not tolerated by titanium or stainless steel.

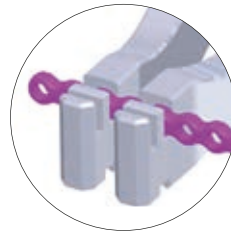

Fig. 3

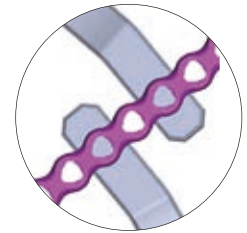

Fig. 4

## Technical Specifications

- ▶ Titanium is the most biocompatible metal
- ▶ Polyaxial, bi- and monocortical locking
- ▶ Eliminates abrasion
- ▶ Geometrically optimised for maximal strength
- ▶ Plates can be bent in three planes



Fig. 5

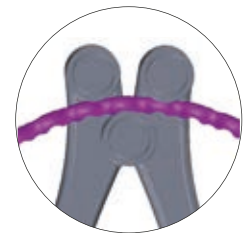

Fig. 6

## Biological Benefits

- ▶ Reduces damage to the vascular supply
- ▶ Increases resistance to infection
- ▶ Accelerates healing

## Application

- ▶ For small animals up to 15 kg

### Literature:

Perren SM, – Evolution of the internal fixation of long bone fractures. The scientific basis of biological internal fixation: choosing a new balance between stability and biology. *J Bone Joint Surg Br.* 2002 Nov;84(8): 1093-110.

P. Cronier et al. – the concept of locking plates – *Orthopaedics & Traumatology: Surgery & Research* (2010) 96S, S17–S36



Fig. 7



Fig. 8

# EICKLOXX SMALL OSTEOSYNTHESIS SYSTEM – ITEM LIST

EickLoxx Small Osteosynthesis System		
Item No.	Description	Quantity
185500	Complete set, consisting of:	
185501	EickLoxx Small Instrument Tray, without instruments	1
185502	EickLoxx Small Implant Tray, without implants	1
185503	EickLoxx Small Screw Implant Module, without screws	1
185504	TAURUS Plates and Wire Cutting Pliers, L 230 mm, up to plates/wire thickness of 2.1 / 2.7 mm	1
185505	Plate Bending Pliers with Rollers	1
185506	EickLoxx Small Bending Levers, pair	2
185507	Twist Drill, Ø 1.4 mm, AO Quick Coupling	1
185508	Twist Drill, Ø 1.8 mm, AO Quick Coupling	1
185509	Twist Drill, Ø 2.0 mm, AO Quick Coupling	1
185510	Screwdriver Blade, Torx 6, AO Quick Coupling	1
185511	Screwdriver Blade, Torx 10, AO Quick Coupling	1
185515	Silicone Screwdriver Handle, cannulated, AO Quick Coupling, L 120 mm	1
185512	Drill Guide Funnel, multi-directional, 1.7 / 2.3	1
185513	Drill Guide Funnel, multi-directional, 2.7 / 3.5 / 4.0	1
185514	Plate and Screw Holding Forceps, titanium, angled, L 150 mm	1
185516	Plate Positioning Pin, Ø 1.4 x L 63 mm	4
185517	Depth Gauge, measuring range 30 mm, probe 1.0 mm	1
185518	EickLoxx Small Bone Plate, 46 holes, 1.7 / 2.3, titanium, magenta, dimensions (in mm): L 230 x W 5.0 x H 2.0	1
185519	EickLoxx Small Bone Plate, 41 holes, 1.7 / 2.3, titanium, magenta, dimensions (in mm): L 225 x W 6.5 x H 2.4	1
185520	EickLoxx Small Bone Plate, 28 holes, 2.7 / 3.5, titanium, magenta, dimensions (in mm): L 224 x W 8.0 x H 2.7	1
185521	Titanium Locking Screw, Ø 1.7 x L 8 mm, multi-directional, silver, Torx 6, self-drilling, self-tapping	4
185522	Titanium Locking Screw, Ø 1.7 x L 10 mm, multi-directional, silver, Torx 6, self-drilling, self-tapping	4
185523	Titanium Locking Screw, Ø 1.7 x L 12 mm, multi-directional, silver, Torx 6, self-drilling, self-tapping	4
185524	Titanium Locking Screw, Ø 1.7 x L 14 mm, multi-directional, silver, Torx 6, self-drilling, self-tapping	4
185525	Titanium Locking Screw, Ø 1.7 x L 16 mm, multi-directional, silver, Torx 6, self-drilling, self-tapping	4
185526	Titanium Locking Screw, Ø 1.7 x L 18 mm, multi-directional, silver, Torx 6, self-drilling, self-tapping	4
185527	Titanium Locking Screw, Ø 1.7 x L 20 mm, multi-directional, silver, Torx 6, self-drilling, self-tapping	4
185528	Titanium Locking Screw, Ø 2.3 x L 8 mm, multi-directional, gold, Torx 6, self-drilling, self-tapping	4
185529	Titanium Locking Screw, Ø 2.3 x L 10 mm, multi-directional, gold, Torx 6, self-drilling, self-tapping	4
185530	Titanium Locking Screw, Ø 2.3 x L 12 mm, multi-directional, gold, Torx 6, self-drilling, self-tapping	4
185531	Titanium Locking Screw, Ø 2.3 x L 14 mm, multi-directional, gold, Torx 6, self-drilling, self-tapping	4
185532	Titanium Locking Screw, Ø 2.3 x L 16 mm, multi-directional, gold, Torx 6, self-drilling, self-tapping	4
185533	Titanium Locking Screw, Ø 2.3 x L 18 mm, multi-directional, gold, Torx 6, self-drilling, self-tapping	4
185534	Titanium Locking Screw, Ø 2.3 x L 20 mm, multi-directional, gold, Torx 6, self-drilling, self-tapping	4
185535	Titanium Locking Screw, Ø 2.7 x L 10 mm, multi-directional, light blue, Torx 10, self-drilling, self-tapping	4
185536	Titanium Locking Screw, Ø 2.7 x L 12 mm, multi-directional, light blue, Torx 10, self-drilling, self-tapping	4
185537	Titanium Locking Screw, Ø 2.7 x L 14 mm, multi-directional, light blue, Torx 10, self-drilling, self-tapping	4
185538	Titanium Locking Screw, Ø 2.7 x L 16 mm, multi-directional, light blue, Torx 10, self-drilling, self-tapping	4
185539	Titanium Locking Screw, Ø 2.7 x L 18 mm, multi-directional, light blue, Torx 10, self-drilling, self-tapping	4
185540	Titanium Locking Screw, Ø 2.7 x L 20 mm, multi-directional, light blue, Torx 10, self-drilling, self-tapping	4
185541	Titanium Locking Screw, Ø 2.7 x L 22 mm, multi-directional, light blue, Torx 10, self-drilling, self-tapping	4
185542	Titanium Locking Screw, Ø 2.7 x L 24 mm, multi-directional, light blue, Torx 10, self-drilling, self-tapping	4
185543	Titanium Locking Screw, Ø 2.7 x L 26 mm, multi-directional, light blue, Torx 10, self-drilling, self-tapping	4
185544	Titanium Locking Screw, Ø 2.7 x L 28 mm, multi-directional, light blue, Torx 10, self-drilling, self-tapping	4
185545	Titanium Locking Screw, Ø 2.7 x L 30 mm, multi-directional, light blue, Torx 10, self-drilling, self-tapping	4
185555	Container, non-perforated bottom, perforated lid, silver, dimensions (in mm): L 312 x W 183 x H 122	1

Optional Accessories		
Item No.	Description	Quantity
185557	Titanium Locking Screw, Ø 1.7 x L 6 mm, multi-directional, silver, Torx 6, self-drilling, self-tapping	1
185558	Titanium Locking Screw, Ø 1.7 x L 7 mm, multi-directional, silver, Torx 6, self-drilling, self-tapping	1
185559	Titanium Locking Screw, Ø 2.3 x L 6 mm, multi-directional, gold, Torx 6, self-drilling, self-tapping	1
185560	Titanium Locking Screw, Ø 2.3 x L 7 mm, multi-directional, gold, Torx 6, self-drilling, self-tapping	1



# EickLoxx Small

A polyaxial locking osteosynthesis system for cats and small dogs up to 15 kg

*Locking osteosynthesis systems (or so-called fixateur interne) offer an enormous advantage where screws and plates form a stable unit compared to the long-time used DCP and LCP bone plates.*

*This not only ensures a significantly better holding force in the bone, but the plates do not press onto the bone, promoting blood circulation and leads to less frequent refractures after implant removal. ►*

## Conventional systems

In conventional systems screws press the plate onto the bone as the screw is tightened. The threads of the screw pull and slightly deform the bone that the threads engage, and force occurs.

However, if axial forces are added to the compressive forces that occur more frequently during running and jumping effecting the long bones, then a second further component acts on the screw: shearing (shear effect). The shear effect (Fig. 1b) occurs in the proximal area of the screw below the plate, with the screw tip counteracting withdrawal forces at the counter cortical bone.

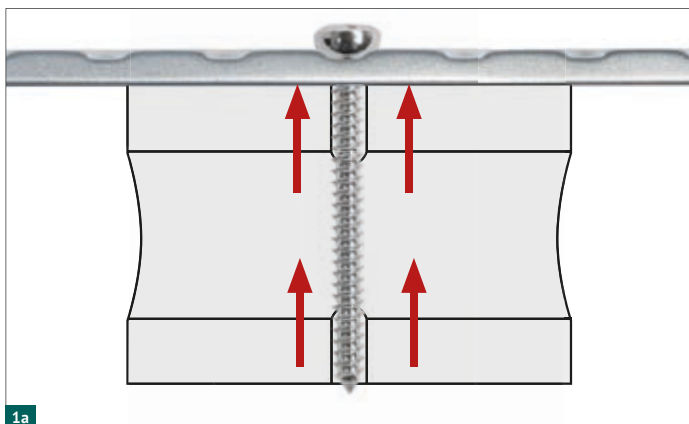

Fig. 1a: Effect of compression on the overall thread in contact with the bone (according to Cronier et al., 2010)

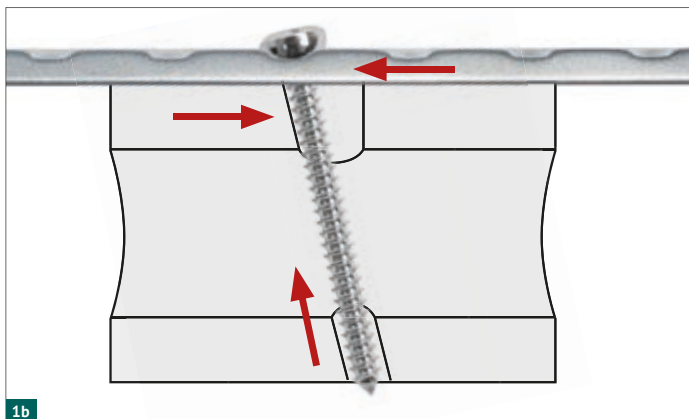

Fig. 1b: Shearing effect occurs on the proximal side of the screw only. The tip of the screw acts almost solely in relation to the pullout forces (according to Cronier et al., 2010)

Because bone is viscoelastic and remodels, the traction over the first several minutes after plate application reduces due to bone relaxation (material “creep”). Further loss of tension occurs over days and weeks due to remodelling of the living reacting bone (according to Cronier et al., 2010).

In conventional systems, caused by the pressure of the plate on the bone, significant vascular damage occurs. This can lead to delayed fracture healing and, after removal of the plate, to an increased risk of refractures (Perren, 2002).

## Locking systems

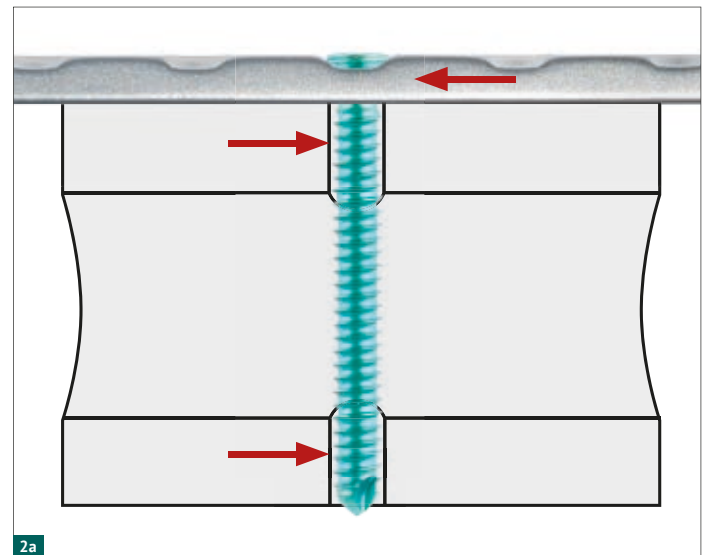

Fig. 2a: A locking screw resists shearing along its entire screw length (according to Cronier et al., 2010)

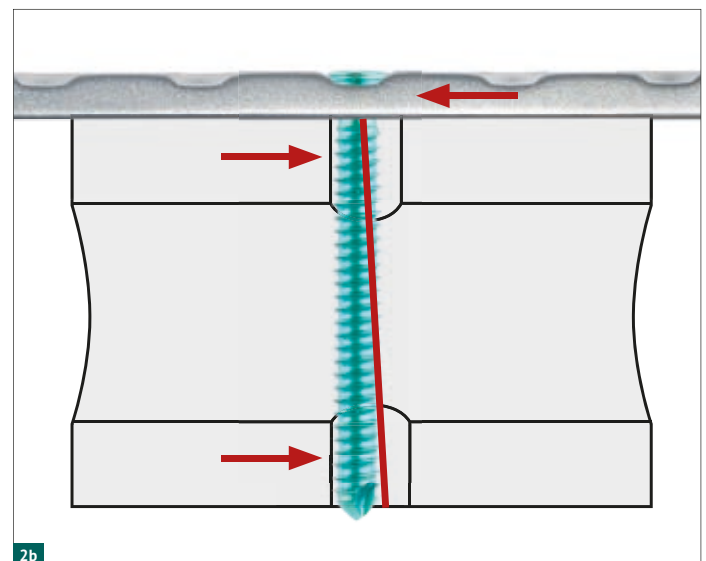

Fig. 2b: A locking screw also counteracts flexion forces (according to Cronier et al., 2010)

In contrast, locking systems such as the EickLoxx Small always function as “buttress systems” – even when they are applied to an anatomically reconstructed fracture (Fig. 2a and 2b). Because the plate is not pressed by the screws on the fracture, the fracture area can heal virtually unimpeded, which is especially advantageous in comminuted fractures with blood vessel injuries. In locking systems, the plate and screws form one unit.

For this reason, there is minimal loosening of the system through bone deformation under load (Fig. 3a) – in contrast, DCP or LCP and other non-locking systems, can experience the loosening of individual screws which can ultimately lead to the loss of the entire fixation Fig. 3b). ►

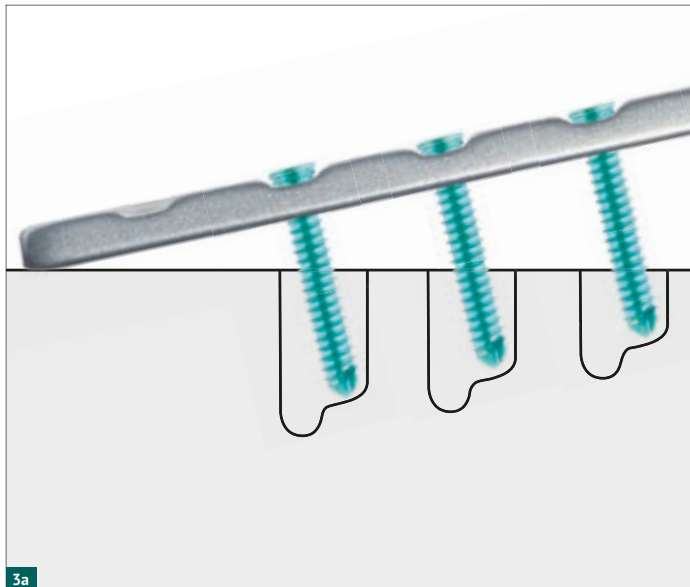

Fig. 3a: Locking System (according to Cronier et al., 2010)



Fig. 3b: DCP or LC-DCP system (according to Cronier et al., 2010)

Figures 3a and 3b illustrate the pullout mechanism of the respective plate-screw connection principles under stress. In locking systems, the head thread of the screw is screwed into the plate hole thread. This creates a mechanically stable connection between the screws and plate, or the locking results.

The screws of interlocking plates act as transverse supporting members, subjected to cantilever bending. The primary loads on the bone during weight-bearing are axial, along the long axis of the bone. Here, there is no pulling of the plate down to the screw, so the likelihood of pullout of the screw is reduced. Importantly, the screw is an integral part of the transmission of forces across fracture sites. Locking systems invariably function in a support capacity.

## Screw characteristics

Locking screws differ from conventional cortical screws. The core diameter of a locking screw is bigger and has a fine-pitched thread compared with conventional bone screw threads (Fig. 4a and 4b).

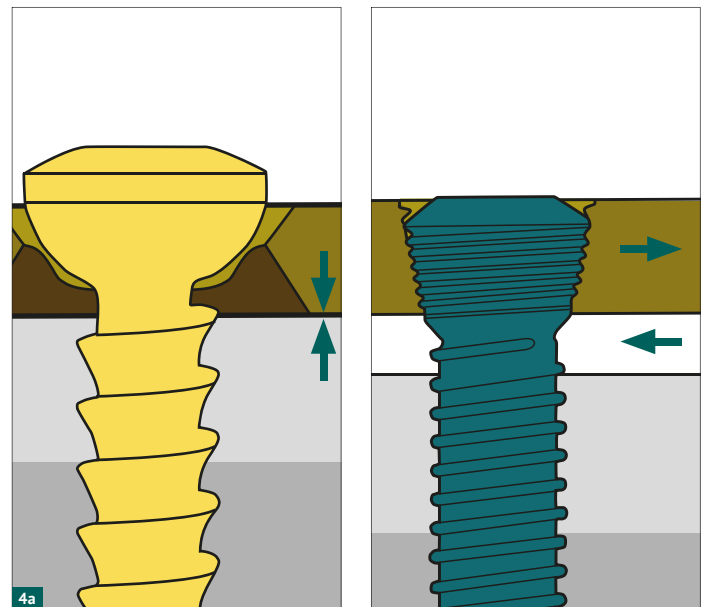

Fig. 4a: Conventional screw, locking screw (according to Cronier et al., 2010)

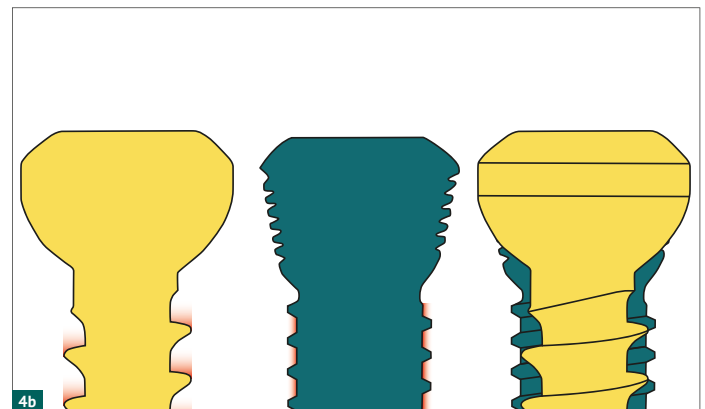

Fig. 4b: Differences in the diameter of conventional and locking screws (according to Cronier et al., 2010)

Due to this improved holding force of the screws, (determined by the locking mechanism screw head thread in the plate hole thread, as well as the screw characteristics) they can also be used monocortical. This is an advantage especially for small dogs and cats or in the use of additional intramedullary nails.

## EickLoxx Small Osteosynthesis System

The most important steps for handling the EickLoxx Small Osteosynthesis System and the description of the components are shown in Figures 5 to 9. ►



Fig. 5: The 1.7 mm and 2.3 mm locking screws can be combined with each other in the 2.0 x 5.0 mm and 2.4 x 6.5 mm plates.

Polyaxial positioning of the screws also gives the surgeon flexibility when guiding the screws in the area close to the joint.

The geometry of the screw heads and screw holes enables multidirectional screwing in via a jig funnel in  $\pm 15^\circ$  longitudinal and transverse pivoting (with the funnel-shaped drill sleeve being screwed vertically into the screw hole).



Fig. 6: The drill guide funnel is screwed vertically into the plate hole thread. With the twist drill, the inclination of the locking screws can be determined (up to  $\pm 15^\circ$  longitudinal and transverse pivoting).

Another advantage of the EickLoxx Small locking plate system is that it has a modular design. There are three plate thicknesses available (2.0 mm, 2.4 mm and 2.7 mm) which can be cut as required and are bendable in all three planes, thanks to special tools. The surgeon also has the option of using 1.7 mm or 2.3 mm size screws for the two smaller plates. The largest of the three currently uses 2.7 mm and 3.5 mm screws (refer to chapters 2, EickLoxx Large and 7.3, EickLoxx TPLO). Thus, the EickLoxx Small allows the surgeon a maximum of flexibility and modularity.

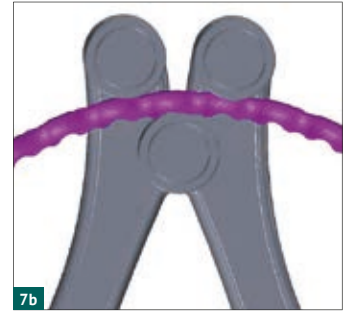
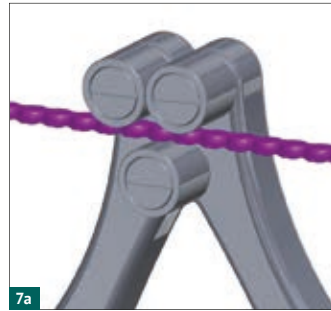

Fig. 7a and 7b: When an EickLoxx plate is bent in the plane of the plate, the holes remain round because of the special mechanism of the bending pliers with rollers.

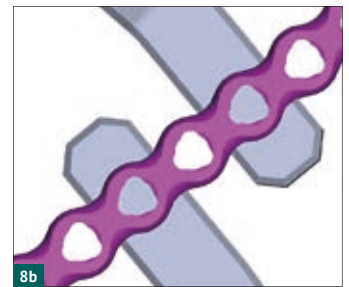

Fig. 8a and 8b: Bending a plate perpendicular to the plate plane

## Summary

- EickLoxx Small is a flexible and modular plate – osteosynthesis system for cats and small dogs up to 15 kg
- EickLoxx bone plates minimise contact with the periosteum and thus reduce the iatrogenic load on the bone perfusion, common in conventional compression plates.
- Preservation of perfusion significantly reduces the risk of infection and accelerates bone healing.
- Resistance to infection is also enhanced by the biocompatibility of titanium and the absence of fretting.

### Literature:

P. Cronier, G. Pietu, C. Dujardin, N. Bigorre, F. Ducellier, R. Gerard. *The concept of locking plates. Orthopaedics & Traumatology: Surgery & Research (2010); 96S: S17–S36.*  
 S.M. Perren. *Evolution of the internal fixation of long bone fractures. The scientific basis of biological internal fixation: choosing a new balance between stability and biology. J Bone Joint Surg Br. (2002); Nov; 84(8): 1093-110.*



**Dr. Daniel Koch**  
*Specialist in small animal surgery; DECVS*

Specialist in small animal surgery; DECVS;  
 Specialisations: joint surgery, osteosynthesis, airway obstruction and dental treatment; Research areas: brachycephalic syndrome, knee joint of the dog.

## Case Report 1

Dr. Daniel Koch, Diessenhofen, Switzerland, June 18th, 2018  
cat, 1 year, 2 kg, car accident 4 days ago, femur diaphysis fracture, right

I used the EickLoxx Small system for the first time.

**Conclusion:** very good, applicable, looks very stable, simple handling, fast OR.



Fig. 5: cut the plate between the holes ...

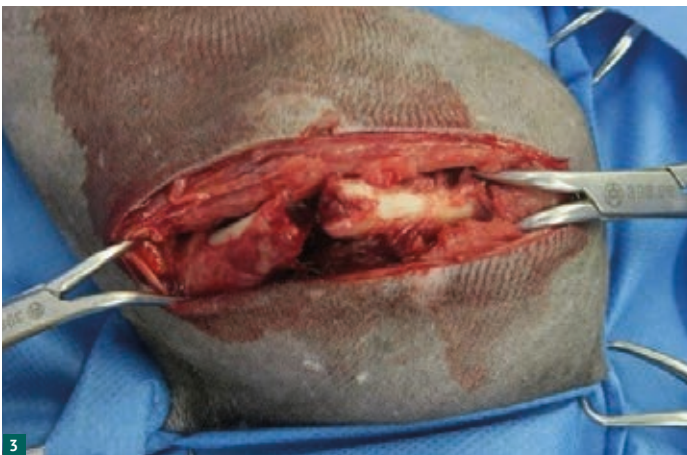

Fig. 3: bone fragments repositioning

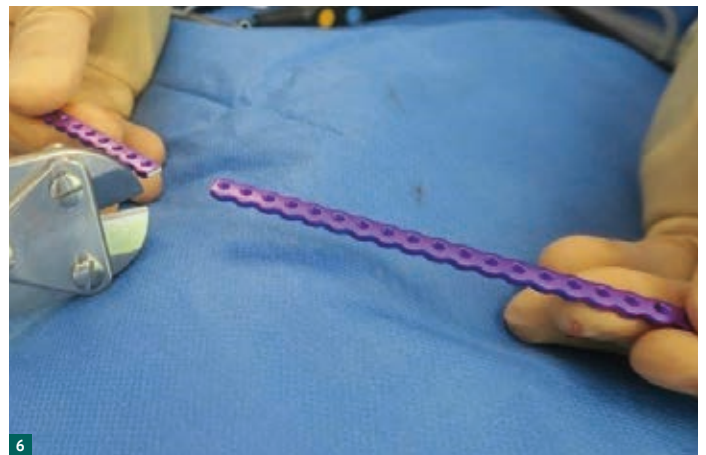

Fig. 6: ... to the length measured intraoperatively



Fig. 4: in situ measuring of the plate length



Fig. 7: in-plane plate-bending with the Plate Bending Pliers with Rollers



Fig. 8: insertion of the Plate Positioning Pins

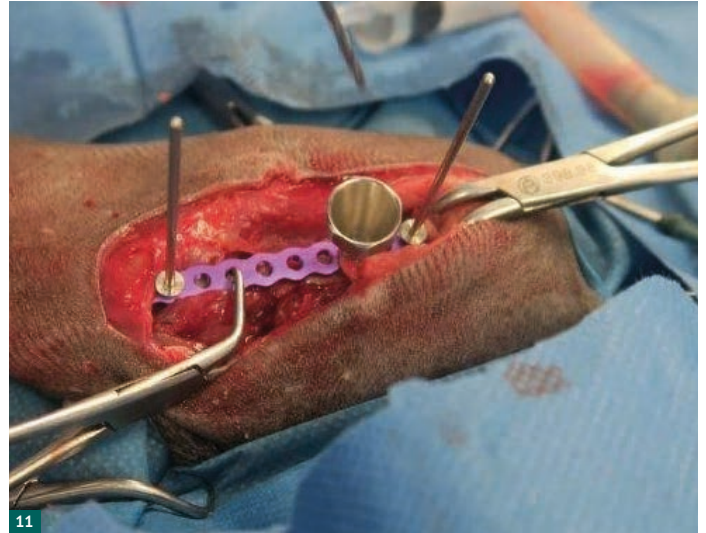

Fig. 11: ...otherwise the Drill Guide Funnel cannot be screwed on

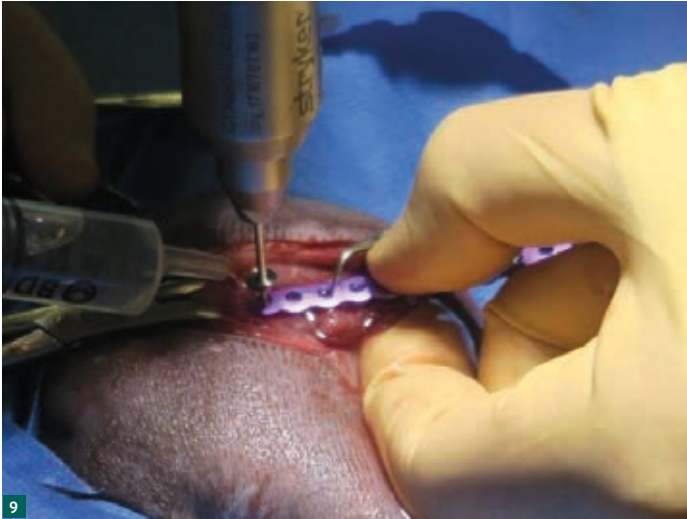

Fig. 9: screwing in of the Plate Positioning Pin for temporary plate fixation



Fig. 12: the Drill Guide Funnel is too close to the Plate Positioning Pin

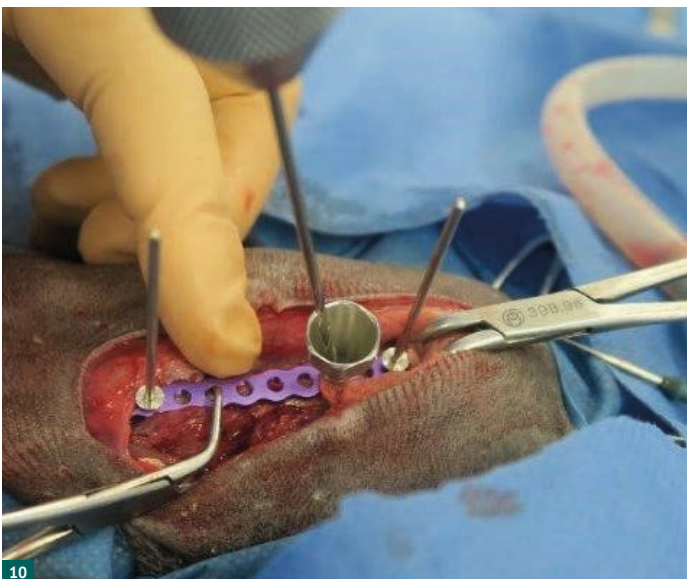
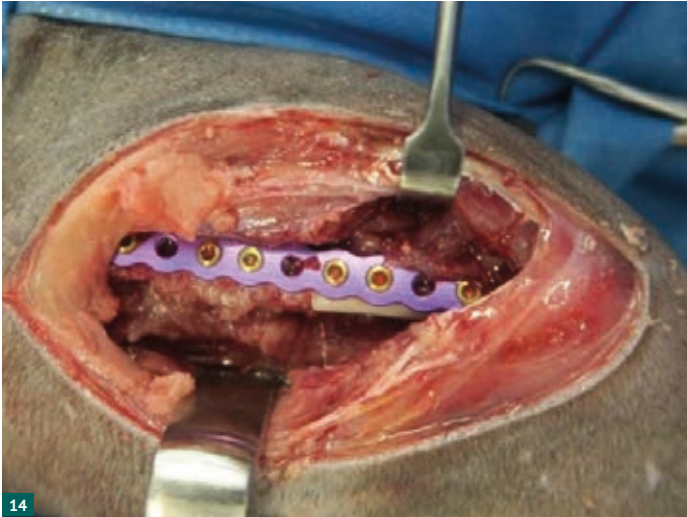

Fig. 10: in the case of temporary plate fixation, care must be taken to leave at least a one hole gap between the Plate Positioning Pins and the Drill / Sleeve Guide Funnel, ...



Fig. 13: screwing in the locking screw in an angle of  $\pm 15^\circ$  in longitudinal and transverse pivoting is possible



14

Fig. 14: compared to a conventional plate-screw-system, like DCP/LCP, there is no need for every screw hole to have a screw (because locking systems like the EickLoxx Small form a stable plate and screw unit)



15



16

## Case Report 2

Dr. Daniel Koch, Diessenhofen, Switzerland, June 25th, 2018  
Yorkshire Terrier, 6 months, 1.7 kg, radius / ulna fracture



Fig. 1: use of 5.0 x 2.0 mm plate cut to a 9 hole plate length



Fig. 4: fracture with the 9 hole plate, length approximately 4.5 cm with 7 x 2.3 mm screws fixed

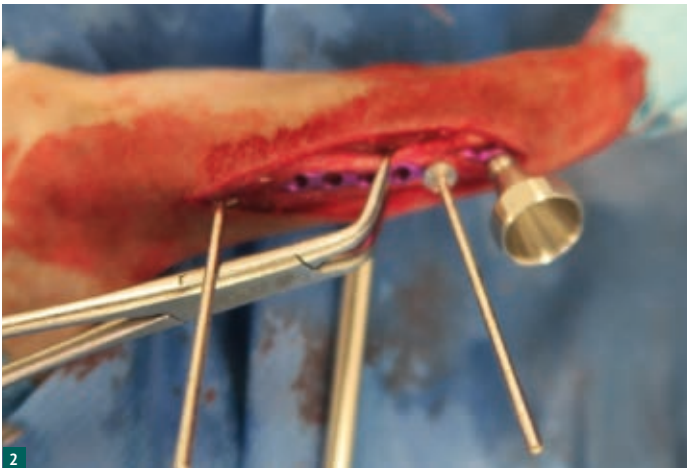

Fig. 2: plate with 2 Plate Positioning Pins...

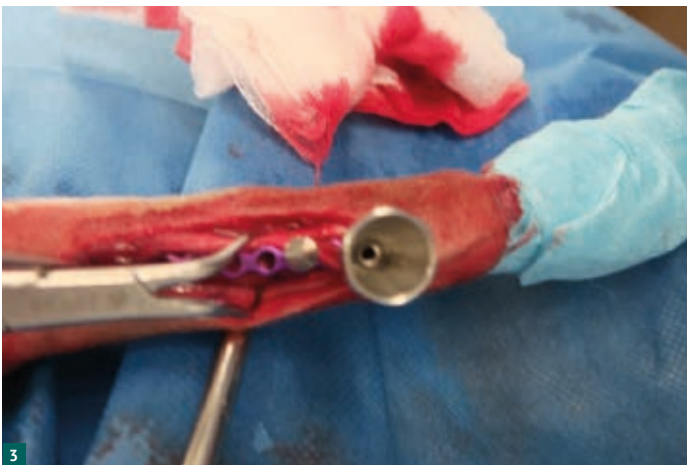

Fig. 3: ...and screwed on Drill Guide Funnel



5



6

Fig. 5 & 6: Yorkshire Terrier, 6 months, 1.7 kg, radius/ulna fracture



## Case Report 3

Dr. Daniel Koch, Diessenhofen, Switzerland, July 24th, 2018  
cat, 4 years, accident, ileum fracture

First tried conservatively, then 3 weeks later osteosynthesis at the ilium with EickLoxx Small. The repositioning took time and effort due to the proximity of the hip joint, but the ability to angle the screws allowed for a much better lock with the plate.

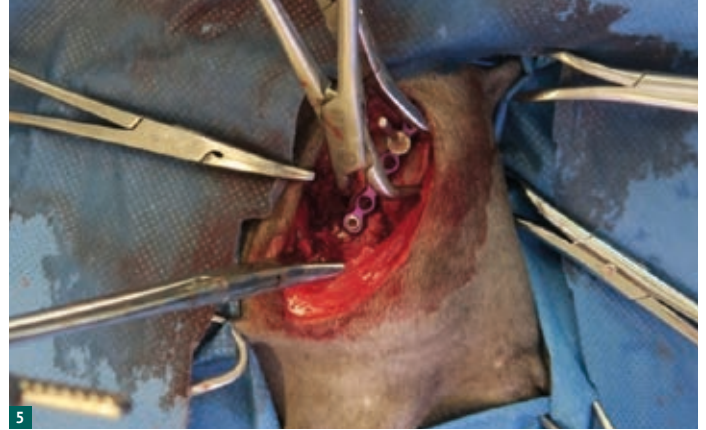

Fig. 5: Plate with Plate Positioning Pin and first 2.3 mm screw

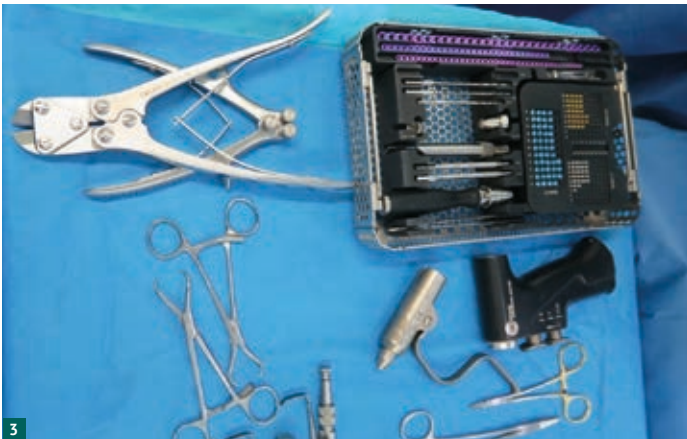

Fig. 3: EickLoxx Small osteosynthesis system, necessary instrumentation and orthopaedic drill.



Fig. 6: 5 x 2.3 mm screws locked multidirectionally



Fig. 4: Use of a 5.0 x 2.0 mm plate cut to a 7 hole plate, length approximately 3.5 cm



## Case Report 4

Dr. Daniel Koch, Diessenhofen, Switzerland, August 6th, 2018  
Maine Coon cat, 2 years, 7 kg GG, Monteggia fracture

Maine Coon cat, 2 years, 7 kg GG, fell 7 m, Radial head luxation and Ulna fracture (so called Monteggia fracture). Treated today with plate at the Ulna and loop technique according to Koch.



Fig. 5: Locking with 7 x 2.3 mm screws, partially multidirectional, on a 10 holes cut plate about 5.0 cm length

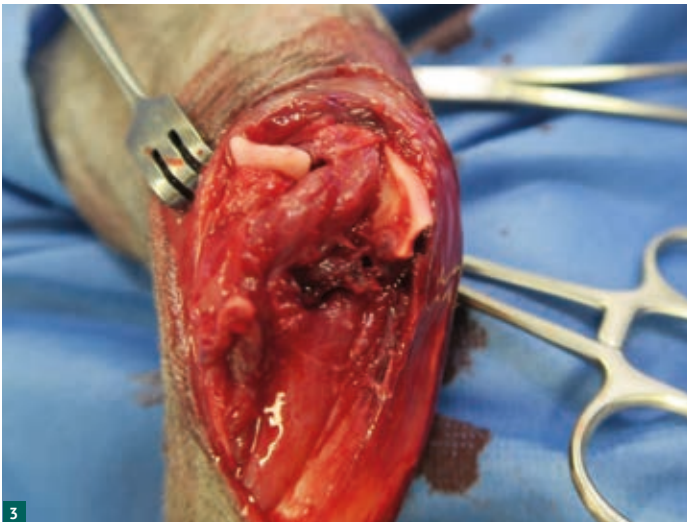

Fig. 3: OR – elbow status



Fig. 4: use of a 5.0 x 2.0 mm plate with two Plate Positioning Pins for temporary plate fixation

### Case Report 5: Simple repair of Monteggia fractures in the cat

#### Case report



Scan the QR code to see the Case Report (in German)

SAT | ASMV 11 | 2017 Volume 159, Issue 11, November 2017, 601–604, © GST | SVS

Monteggia fractures are rare traumatic injuries in cats and dogs. Ulna repair is mostly achieved by plates. Stable radial head fixation however is challenging. Temporary position screws have to be removed due to rotation forces in the elbow joint causing screw loosening. We present a novel and simple method using a sling technique, which holds the radial head in its physiological position and allows normal elbow movement.

#### Keywords:

Monteggia, fracture, radius, ulna, osteosynthesis, sling

**Daniel Koch, Dr. med. vet. ECVS**  
**Daniel Koch Kleintierchirurgie AG**  
Ziegeleistrasse 5  
CH 8253 Diessenhofen

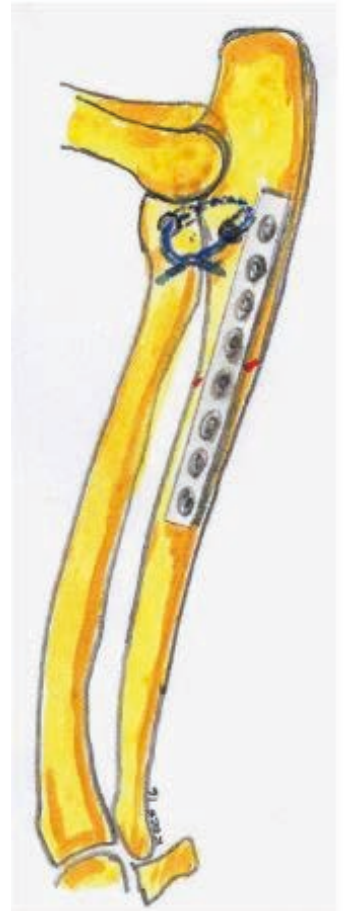

Schematic illustration of the suture guidance for reposition and position holding of the radial head in Monteggia fractures.

## EICKLOXX SMALL OSTEOSYNTHESIS SYSTEM – VIDEO

---

EickLoxx Small application video (in German)



# EICKEMEYER®

Your partner in  
Orthopaedics



**EickLoxx**

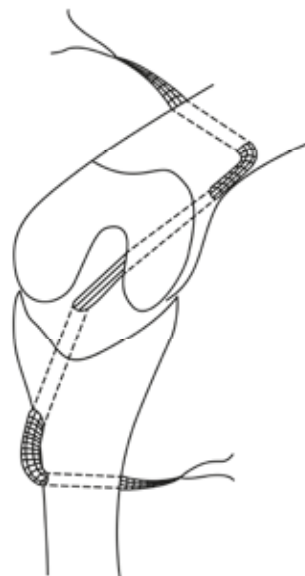

**Zlig**



**CBS**

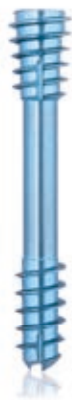

**OrthoVet**



Go online now to find out more:  
[www.eickemeyer.com/orthopaedic-implants](http://www.eickemeyer.com/orthopaedic-implants)

# EickLoxx Large

A universal osteosynthesis system for small animals between 15 and 45 kg



# EICKLOXX LARGE OSTEOSYNTHESIS SYSTEM – COMPONENTS AND CHARACTERISTICS

The newly developed EickLoxx Large is an angle-stable osteosynthesis system for dogs with a weight of approx. 15–45 kg.

Just like the EickLoxx Small, the system is characterised by a polyaxial placement of the precisely shaped screws and thus combines the advantages of angle-stable systems and the possibility of placing the screws at an angle of up to  $\pm 15^\circ$ . Like the EickLoxx Small, the EickLoxx Large offers the advantage of rapid fracture healing with improved implant strength. For this reason, the removal of screws and plates is rarely indicated here.

The biocompatible titanium S-shaped plates are available in eight different sizes. Thanks to special tools, the plates can be bent on all three planes. The long 12- and 14-hole plates as well as the long 34 to 40 mm screws ( $\varnothing$  2.7 / 3.5 / 4.0) are not included in the basic set and can be added if required. There is space in the implant tray for the long plates and capacity for the module of the long screws in the instrument tray.

## Titanium EickLoxx Large Bone Plates

- ▶ Bendable in multiple planes
- ▶ Multi-directional locking
- ▶ System 2.7/3.5/4.0
- ▶ 6 EickLoxx Large Bone Plates 4.0 mm, light blue (6–10 holes)
- ▶ 6 EickLoxx Large Bone Plates 4.3 mm, gold (6–10 holes)

**187740 – 187745 / 187750 – 187755**

## Titanium Locking Screws

- ▶ Self-drilling/self-tapping
- ▶ 36 Titanium Locking Screws  $\varnothing$  2.7 mm, light blue (from 10–32 mm)
- ▶ 36 Titanium Locking Screws  $\varnothing$  3.5 mm, magenta (from 10–32 mm)
- ▶ 36 Titanium Locking Screws  $\varnothing$  4.0 mm, blue (from 10–32 mm)

The geometry of the screw head and screw enables polyaxial placement with the Drill Guide System in  $\pm 15^\circ$  longitudinal and transverse pivoting.

**185460 – 185463 / 185535 – 185545 / 185570 – 185581 / 185590 – 185597 / 185600**

## Characteristics

- ▶ EickLoxx Large Bone Plates minimise contact with the periosteum. This reduces the iatrogenic load on the bone perfusion (common in conventional compression plates).
- ▶ Preservation of the bone perfusion significantly reduces the risk of infection and accelerates bone healing.
- ▶ The risk of infection is further reduced through the biocompatibility of titanium and the absence of fretting.

## Biological Benefits

- ▶ Reduces damage to the vascular supply
- ▶ Increases resistance to infection
- ▶ Accelerates healing

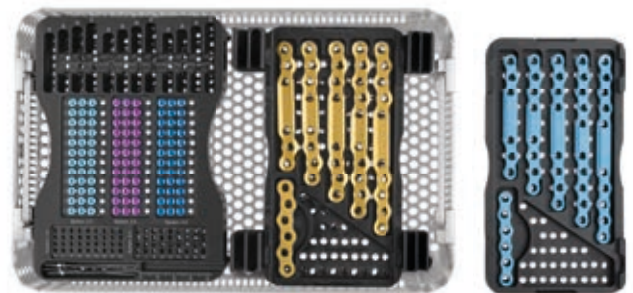
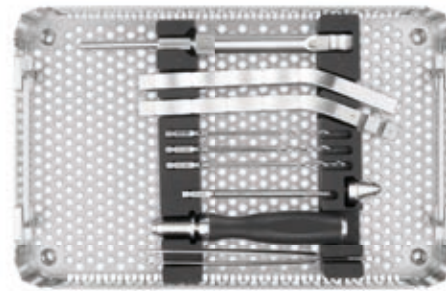

187730

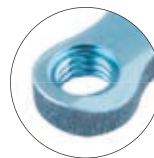

187741

187751



185537

185572

185592

# EICKLOXX LARGE OSTEOSYNTHESIS SYSTEM – ITEM LIST

EickLoxx Large Osteosynthesis System		
Item No.	Description	Quantity
187730	Complete set, consisting of:	
187731	EickLoxx Large Instrument Tray, without instruments	1
187732	EickLoxx Large Implant Tray, without implants	1
187035	EickLoxx Screw Implant Module, without screws	1
187728	EickLoxx Large Bone Plate Tray, for gold S-bone plates	1
187729	EickLoxx Large Bone Plate Tray, for light blue S-bone plates	1
185606	EickLoxx Large Bending Levers, pair	1
185509	Twist Drill, Ø 2.0 mm, AO Quick Coupling	1
197735	Twist Drill, Ø 2.5 mm, AO Quick Coupling	1
187736	Twist Drill, Ø 2.9 mm, AO Quick Coupling	1
185511	Screwdriver Blade, Torx 10, AO Quick Coupling	1
185515	Silicone Screwdriver Handle, cannulated, AO Quick Coupling, L 120 mm	1
185513	Drill Guide Funnel System, 2.7/3.5/4.0	1
185514	Plate and Screw Holding Forceps, titanium, angled, L 150 mm	1
185516	Plate Positioning Pin, Ø 1.4 x L 63 mm	4
187737	Depth Gauge, measuring range 50 mm, probe 1.3 mm	1
187740	EickLoxx Large Bone Plate, 6 holes, titanium, light blue, dimensions (in mm): L 60 x W 10 x H 4.0	1
187741	EickLoxx Large Bone Plate, 6 holes, titanium, light blue, dimensions (in mm): L 80 x W 10 x H 4.0	1
187742	EickLoxx Large Bone Plate, 8 holes, titanium, light blue, dimensions (in mm): L 90 x W 10 x H 4.0	1
187743	EickLoxx Large Bone Plate, 8 holes, titanium, light blue, dimensions (in mm): L 100 x W 10 x H 4.0	1
187744	EickLoxx Large Bone Plate, 10 holes, titanium, light blue, dimensions (in mm): L 110 x W 10 x H 4.0	1
187745	EickLoxx Large Bone Plate, 10 holes, titanium, light blue, dimensions (in mm): L 120 x W 10 x H 4.0	1
187750	EickLoxx Large Bone Plate, 6 holes, titanium, gold, dimensions (in mm): L 60 x W 11 x H 4.3	1
187751	EickLoxx Large Bone Plate, 6 holes, titanium, gold, dimensions (in mm): L 80 x W 11 x H 4.3	1
187752	EickLoxx Large Bone Plate, 8 holes, titanium, gold, dimensions (in mm): L 90 x W 11 x H 4.3	1
187753	EickLoxx Large Bone Plate, 8 holes, titanium, gold, dimensions (in mm): L 100 x W 11 x H 4.3	1
187754	EickLoxx Large Bone Plate, 10 holes, titanium, gold, dimensions (in mm): L 110 x W 11 x H 4.3	1
187755	EickLoxx Large Bone Plate, 10 holes, titanium, gold, dimensions (in mm): L 120 x W 11 x H 4.3	1
185535	Titanium Locking Screw, Ø 2.7 x L 10 mm, multi-directional, light blue, Torx 10, self-drilling, self-tapping	3
185536	Titanium Locking Screw, Ø 2.7 x L 12 mm, multi-directional, light blue, Torx 10, self-drilling, self-tapping	3
185537	Titanium Locking Screw, Ø 2.7 x L 14 mm, multi-directional, light blue, Torx 10, self-drilling, self-tapping	3
185538	Titanium Locking Screw, Ø 2.7 x L 16 mm, multi-directional, light blue, Torx 10, self-drilling, self-tapping	3
185539	Titanium Locking Screw, Ø 2.7 x L 18 mm, multi-directional, light blue, Torx 10, self-drilling, self-tapping	3
185540	Titanium Locking Screw, Ø 2.7 x L 20 mm, multi-directional, light blue, Torx 10, self-drilling, self-tapping	3
185541	Titanium Locking Screw, Ø 2.7 x L 22 mm, multi-directional, light blue, Torx 10, self-drilling, self-tapping	3
185542	Titanium Locking Screw, Ø 2.7 x L 24 mm, multi-directional, light blue, Torx 10, self-drilling, self-tapping	3
185543	Titanium Locking Screw, Ø 2.7 x L 26 mm, multi-directional, light blue, Torx 10, self-drilling, self-tapping	3
185544	Titanium Locking Screw, Ø 2.7 x L 28 mm, multi-directional, light blue, Torx 10, self-drilling, self-tapping	3
185545	Titanium Locking Screw, Ø 2.7 x L 30 mm, multi-directional, light blue, Torx 10, self-drilling, self-tapping	3
185600	Titanium Locking Screw, Ø 2.7 x L 32 mm, multi-directional, light blue, Torx 10, self-drilling, self-tapping	3
185570	Titanium Locking Screw, Ø 3.5 x L 10 mm, multi-directional, magenta, Torx 10, self-drilling, self-tapping	3
185571	Titanium Locking Screw, Ø 3.5 x L 12 mm, multi-directional, magenta, Torx 10, self-drilling, self-tapping	3
185572	Titanium Locking Screw, Ø 3.5 x L 14 mm, multi-directional, magenta, Torx 10, self-drilling, self-tapping	3
185573	Titanium Locking Screw, Ø 3.5 x L 16 mm, multi-directional, magenta, Torx 10, self-drilling, self-tapping	3
185574	Titanium Locking Screw, Ø 3.5 x L 18 mm, multi-directional, magenta, Torx 10, self-drilling, self-tapping	3
185575	Titanium Locking Screw, Ø 3.5 x L 20 mm, multi-directional, magenta, Torx 10, self-drilling, self-tapping	3
185576	Titanium Locking Screw, Ø 3.5 x L 22 mm, multi-directional, magenta, Torx 10, self-drilling, self-tapping	3
185577	Titanium Locking Screw, Ø 3.5 x L 24 mm, multi-directional, magenta, Torx 10, self-drilling, self-tapping	3

# EICKLOXX LARGE OSTEOSYNTHESIS SYSTEM – ITEM LIST

EickLoxx Large Osteosynthesis System		
Item No.	Description	Quantity
185578	Titanium Locking Screw, Ø 3.5 x L 26 mm, multi-directional, magenta, Torx 10, self-drilling, self-tapping	3
185579	Titanium Locking Screw, Ø 3.5 x L 28 mm, multi-directional, magenta, Torx 10, self-drilling, self-tapping	3
185580	Titanium Locking Screw, Ø 3.5 x L 30 mm, multi-directional, magenta, Torx 10, self-drilling, self-tapping	3
185581	Titanium Locking Screw, Ø 3.5 x L 32 mm, multi-directional, magenta, Torx 10, self-drilling, self-tapping	3
185590	Titanium Locking Screw, Ø 4.0 x L 10 mm, multi-directional, blue, Torx 10, self-drilling, self-tapping	3
185591	Titanium Locking Screw, Ø 4.0 x L 12 mm, multi-directional, blue, Torx 10, self-drilling, self-tapping	3
185592	Titanium Locking Screw, Ø 4.0 x L 14 mm, multi-directional, blue, Torx 10, self-drilling, self-tapping	3
185593	Titanium Locking Screw, Ø 4.0 x L 16 mm, multi-directional, blue, Torx 10, self-drilling, self-tapping	3
185594	Titanium Locking Screw, Ø 4.0 x L 18 mm, multi-directional, blue, Torx 10, self-drilling, self-tapping	3
185595	Titanium Locking Screw, Ø 4.0 x L 20 mm, multi-directional, blue, Torx 10, self-drilling, self-tapping	3
185596	Titanium Locking Screw, Ø 4.0 x L 22 mm, multi-directional, blue, Torx 10, self-drilling, self-tapping	3
185597	Titanium Locking Screw, Ø 4.0 x L 24 mm, multi-directional, blue, Torx 10, self-drilling, self-tapping	3
185460	Titanium Locking Screw, Ø 4.0 x L 26 mm, multi-directional, blue, Torx 10, self-drilling, self-tapping	3
185461	Titanium Locking Screw, Ø 4.0 x L 28 mm, multi-directional, blue, Torx 10, self-drilling, self-tapping	3
185462	Titanium Locking Screw, Ø 4.0 x L 30 mm, multi-directional, blue, Torx 10, self-drilling, self-tapping	3
185463	Titanium Locking Screw, Ø 4.0 x L 32 mm, multi-directional, blue, Torx 10, self-drilling, self-tapping	3
185555	Container, non-perforated bottom, perforated lid, silver, dimensions (in mm): L 312 x W 183 x H 122 mm	1

Optional Accessories		
Item No.	Description	Quantity
187746	EickLoxx Large Bone Plate, 12 holes, titanium, light blue, dimensions (in mm): L 130 x W 10 x H 4.0	1
187747	EickLoxx Large Bone Plate, 14 holes, titanium, light blue, dimensions (in mm): L 160 x W 10 x H 4.0	1
187756	EickLoxx Large Bone Plate, 12 holes, titanium, gold, dimensions (in mm): L 140 x W 11 x H 4.3	1
187757	EickLoxx Large Bone Plate, 14 holes, titanium, gold, dimensions (in mm): L 160 x W 11 x H 4.3	1
185601	Titanium Locking Screw, Ø 2.7 x L 34 mm, multi-directional, light blue, Torx 10, self-drilling, self-tapping	1
185602	Titanium Locking Screw, Ø 2.7 x L 36 mm, multi-directional, light blue, Torx 10, self-drilling, self-tapping	1
185603	Titanium Locking Screw, Ø 2.7 x L 38 mm, multi-directional, light blue, Torx 10, self-drilling, self-tapping	1
185604	Titanium Locking Screw, Ø 2.7 x L 40 mm, multi-directional, light blue, Torx 10, self-drilling, self-tapping	1
185582	Titanium Locking Screw, Ø 3.5 x L 34 mm, multi-directional, magenta, Torx 10, self-drilling, self-tapping	1
185583	Titanium Locking Screw, Ø 3.5 x L 36 mm, multi-directional, magenta, Torx 10, self-drilling, self-tapping	1
185584	Titanium Locking Screw, Ø 3.5 x L 38 mm, multi-directional, magenta, Torx 10, self-drilling, self-tapping	1
185585	Titanium Locking Screw, Ø 3.5 x L 40 mm, multi-directional, magenta, Torx 10, self-drilling, self-tapping	1
185464	Titanium Locking Screw, Ø 4.0 x L 34 mm, multi-directional, blue, Torx 10, self-drilling, self-tapping	1
185465	Titanium Locking Screw, Ø 4.0 x L 36 mm, multi-directional, blue, Torx 10, self-drilling, self-tapping	1
185466	Titanium Locking Screw, Ø 4.0 x L 38 mm, multi-directional, blue, Torx 10, self-drilling, self-tapping	1
185467	Titanium Locking Screw, Ø 4.0 x L 40 mm, multi-directional, blue, Torx 10, self-drilling, self-tapping	1



# UFEG<sup>®</sup>

External Skeletal Fixation System (ESF) is a U-shaped steel rail with a built-in reinforced threaded plate



## UFEG® – COMPONENTS

### Design of UFEG® and principle of operation

The UFEG® is a U-shaped steel rail with an incorporated threaded reinforced plate. This design fulfills two functions: the connecting rod and the clamping connection of K-wires and STEINMANN nails, which are fixed in place with Allen screws. The hole geometry is also U-shaped. An additional advantage is that pins with different diameters of 1.0 mm – 4.0 mm can be used in the same rail.



The UFEG® tubular system consists of

### UFEG® ESF Guide Tubes

- ▶ UFEG® ESF Guide Tube Type 2a, 15 hole, weight: 18 g, L 95 mm, Ø 8 mm
- ▶ UFEG® ESF Guide Tube Type 2b, 15 hole, weight: 25 g, L 125 mm, Ø 8 mm
- ▶ UFEG® ESF Guide Tube Type 3a, 15 hole, weight: 49 g, L 150 mm, Ø 10 mm
- ▶ UFEG® ESF Guide Tube Type 3b, 18 hole, weight: 55 g, L 180 mm, Ø 10 mm

### 180970 – 180973

### Allen Screws

- ▶ Allen Screw for UFEG® Type 2a/2b M4 x 6 mm, including Allen key size 2, 10 pieces
- ▶ Allen Screw for UFEG® Type 3a/3b M6 x 6 mm, including Allen key size 3, 10 pieces

### 180974 – 180975

### UFEG® ESF Joint Fixator Kit for joint immobilisation that can be constructed in any angle

Complete set consists of

- ▶ 2x Connecting Plates
- ▶ 5x Inside-Hex-Screws size M

### 180976

### Allen Keys

- ▶ Size 2, for UFEG® Allen Screws Type 2a / 2b
- ▶ Size 3, for UFEG® Allen Screws Type 3a / 3b

### 180979, 180978

Matching STEINMANN pins can be used.

### STEINMANN Positive Profile Pin

- ▶ End Thread
- ▶ Available in different lengths (75 – 116 mm) and diameters (0.9 – 3.2 mm)

### 180501, 180502, 180574, 180572, 180503, 180593, 180496, 180493, 180595, 180497

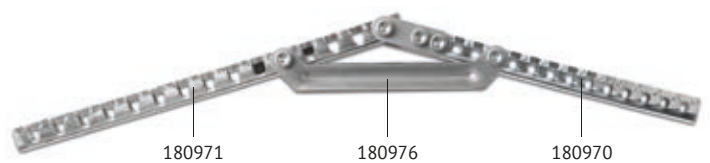
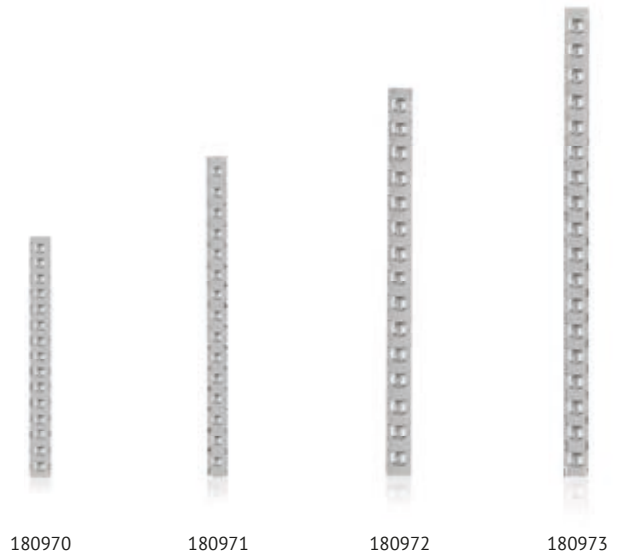

# UFEG® – CHARACTERISTICS

---

## Application

The UFEG® System, like other External Skeletal Fixation Systems (ESF), is a very versatile fixation method that can stabilise a variety of fractures and osteotomies. Indication and application techniques are described in detail within this brochure.

The UFEG® is particularly well-suited for open and infected fractures, severe fractures, and comminuted fractures where several pins need to be used in a confined space. Even simple fractures can be treated quickly and cost-effectively.

In addition, no implants are introduced into the fracture area, promoting flow of the local blood supply and fracture healing.

The UFEG® can be fixed very close to the fracture, either via a closed reduction or with a tissue friendly, minimal access technique. During the healing phase, a dynamisation of the fracture can be made after about 6 weeks. Either the configuration can be changed (for example, Type II to Type I), or individual STEINMANN pins can be gradually removed.

## Advantages

- ▶ The UFEG® can be attached very close to the bone  
*Benefit: Increases the stability of the fracture site*
- ▶ The distance of the UFEG® to the fractured bone can be adjusted at any time  
*Benefit: Increases flexibility in fracture care*
- ▶ The U-shaped rail, about 95 mm in length, weighs only 18 g  
*Benefit: Is very well tolerated by small animals*
- ▶ More pins can be placed in a small space  
*Benefit: More pins increase the stability of the fracture*
- ▶ Different thicknesses of nails or pins can be set in the rail  
*Benefit: Allows flexibility in fracture stabilisation/dynamisation*
- ▶ There are no clamps or additional connecting rods needed  
*Benefit: Simplifies installation and saves time*
- ▶ More threads in the threaded plate and grub screw  
*Benefit: Ensures a stable 3-point fixation of pin and splint*
- ▶ It is a reusable system with only a hex wrench as a tool  
*Benefit: Provides a very cost effective and versatile fixation method*
- ▶ The removal of the UFEG® is usually done under slight sedation  
*Benefit: No additional surgical intervention under anaesthesia*

## Application

- ▶ Especially for dogs, cats, rabbits and birds



Application

## UFEG® – ITEM LIST

UFEG® External Skeletal Fixator		
Item No.	Description	Quantity
180970	UFEG® ESF Guide Tube Type 2a, Ø 8 mm x 95 mm, 15 hole	1
180971	UFEG® ESF Guide Tube Type 2b, Ø 8 mm x 125 mm, 15 hole	1
180972	UFEG® ESF Guide Tube Type 3b, Ø 10 mm x 150 mm, 15 hole	1
180973	UFEG® ESF Guide Tube Type 3b, Ø 10 mm x 180 mm, 18 hole	1
180974	UFEG® Allen Screw for UFEG® ESF Type 2a/2b, M4 x 6 mm including Allen key size 2	10
180975	UFEG® Allen Screw for UFEG® ESF Type 3a/3b, M6 x 6 mm including Allen key size 3	10
180976	UFEG® ESF Joint Fixator Kit for joint immobilisation that can be constructed at any angle. Complete set consisting of: 2x Connecting Plates, 5x Inside-Hex-Screws size M	1
180979	UFEG® Allen Key, size 2, for UFEG® Allen Screws Type 2a / 2b	1
180978	UFEG® Allen Key, size 3, for UFEG® Allen Screws Type 3a / 3b	1

STEINMANN Positive Profile Pins – End Thread		
Item No.	Description	Quantity
180501	STEINMANN Positive Profile Pin, Ø 0.9 x 75 mm, end thread	1
180502	STEINMANN Positive Profile Pin, Ø 1.2 x 75 mm, end thread	1
180574	STEINMANN Positive Profile Pin, Ø 1.2 x 100 mm, end thread	1
180572	STEINMANN Positive Profile Pin, Ø 1.5 x 100 mm, end thread	1
180503	STEINMANN Positive Profile Pin, Ø 1.6 x 75 mm, end thread	1
180593	STEINMANN Positive Profile Pin, Ø 2.0 x 97 mm, end thread	1
180496	STEINMANN Positive Profile Pin, Ø 2.4 x 102 mm, end thread	1
180493	STEINMANN Positive Profile Pin, Ø 2.8 x 110 mm, end thread	1
180595	STEINMANN Positive Profile Pin, Ø 3.0 x 110 mm, end thread	1
180497	STEINMANN Positive Profile Pin, Ø 3.2 x 116 mm, end thread	1

## UFEG® – SPECIALIST ARTICLE

Further articles (in German) can be found here:

### Clinical applications of the UFEG® U-shaped external fixator with threaded plate



### UFEG® U-shaped external fixator with reinforced threaded plate – a new external fixator system



### The U-shaped external fixator with threaded plate, for fracture care in small animals, according to Schumacher



UFEG® is a registered trade mark of Dr. M. Schumacher, Kreuzgasse 27, D – 88677 Marktdorf

# CBS System

Compression Bone Screw System

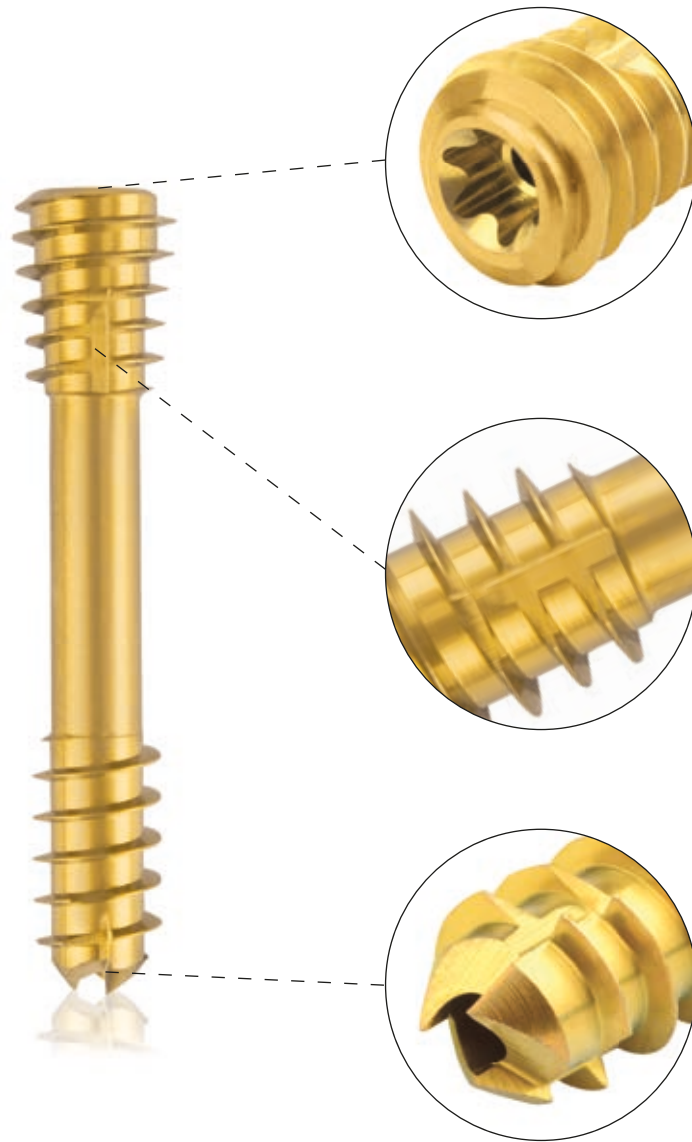

## CBS SYSTEM – COMPONENTS AND CHARACTERISTICS

With its different screw diameters and lengths, the cannulated CBS system enables a wide range of indications for the treatment of fractures in small animal orthopaedics and trauma surgery. CBS stands for Compression Bone Screw and, in its function as a lag screw, enables the compression of two bone fragments.

In contrast to conventional cortex tension screws, which are inserted using a smaller pilot or threaded hole in the distant cortex and a larger spacing or sliding hole in the nearby cortex, the cannulated CBS is screwed in using a KIRSCHNER guide wire. The principle operation of a lag screw with compression is achieved because the threads on the head and the shaft end have different pitches. This gradient difference causes the interosseous compression. The temporary fixation of the bone fragments with the KIRSCHNER wire enables a largely minimally invasive procedure on the one hand, and on the other hand precise screw placement via the KIRSCHNER wire.

The cannulated CBS system is modular and designed for different patient sizes: It comprises a basic instrument set and 4 modules (toy breeds/cat, dog small, dog medium and dog large). The individual modules include a selection of screw lengths and the instruments required for the respective implant size, which are required in addition to the basic instrument set.

### Titanium Compression Screws

- ▶ Self-drilling & self-tapping
- ▶ Cannulated for minimally invasive technique and guided insertion
- ▶ Minimisation of soft tissue irritation through self-cutting grooves on the head thread
- ▶ Cut back flanks in the head and shaft for easier explanation
- ▶ Different diameters (3.0, 4.0, 4.5, 5.5 and 6.5 mm) for a wide range of indications
- ▶ Screw and thread design enable optimal fixation
- ▶ Optimisation of the fracture or osteotomy compression

### Technical Characteristics

- ▶ Screw material: TiAl6V4
- ▶ Easier removal of the implants after the fracture has healed
- ▶ Improved fatigue strength of the implants
- ▶ Reduction of the risk of inflammation and allergies
- ▶ Titanium also reduces artefacts in post-operative imaging
- ▶ Biocompatible
- ▶ Surface anodised with a uniform, continuous passivation layer
- ▶ Colour-coded for easy determination of the size diameter

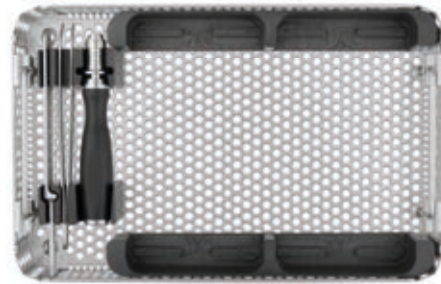

CBS Basic Instrument Set  
Item No. 185105



Micro/High CBS Set – Toy Breeds and Cat  
Item No. 191465



4.5 mm CBS Set – Dog Small  
Item No. 191470



5.5 mm CBS Set – Dog Medium  
Item No. 191475



6.5 mm CBS Set – Dog Large  
Item No. 191480

# CBS SYSTEM – INDICATIONS AND SURGICAL TECHNIQUE

## Application

The compression screws can be used as single implants or in combination with additional KIRSCHNER wires to increase the rotational stability with a target instrument such as, for example, the PinPositioner (191370) or PinCube (191348) which can be used for guided insertion.

## Indications

Fractures, corrective osteotomies, pseudarthroses, degenerative changes in small bones:

- ▶ Sacroiliac luxation
- ▶ Isolated processus anconaeus (IPA)
- ▶ Incomplete ossification of the condylus humeri (IOHC)
- ▶ T/Y fractures of the humeral condyle
- ▶ Intracondylar fractures of the distal femur

## Surgical Technique

### Temporary fixation with the KIRSCHNER wire

Caution: Carefully insert the guide wire to avoid possible bending (tip: grasp the thin guide wires and push them in in small steps).

### Optional Drilling

In the case of strong cortical bone, it is possible to drill out to the core diameter in order to facilitate the insertion of the compression screw with stable angles. Drill over the guide wire with the drill bit.

Attention: The end of the guide wire must not be drilled over to ensure that the guide wire remains firmly held.

### Optional use of a Cortical Bur

If the bone is surrounded by little soft tissue or if the bone quality is very good, the use of the cortical bur is recommended to minimize any soft tissue irritation, protrusion of the screw head in the cortex and to counteract possible deformation of the instruments.

### Determination of Screw Length

Place the length gauge over the guide wire and guide it through the soft tissue to the bone. Then read off the required length at the end of the guide wire.

### Placing the Screw

Screw in the compression screws over the guide wire with the screwdriver (cannulated, AO shaft) up to the head thread. Then remove the guide wire and countersink the screw to the bone surface.

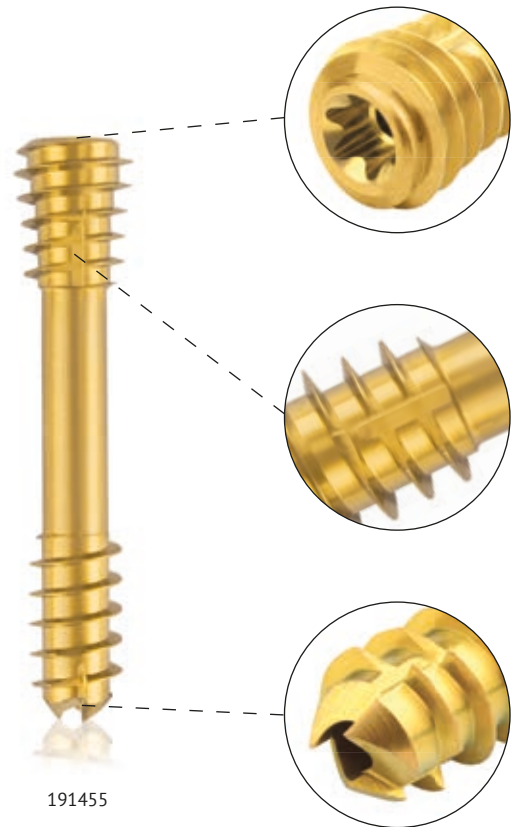

# CBS BASIC INSTRUMENT SET – ITEM LIST

CBS Basic Instrument Set		
Item No.	Description	Quantity
185105	Complete set, consisting of:	
185780	Tray for CBS Implants and Instruments, without implants and instruments	1
185515	Silicone Screwdriver Handle, cannulated, AO Quick Coupling, L 120 mm	1
185779	Plate and Screw Holding Forceps, stainless steel, angled, L 150 mm	1
185781	Screw Length Measuring Device, for KIRSCHNER Wires $\varnothing$ 0.9–1.6 mm, L 150 mm	1



185105



185515



185779



185781





# MICRO / HIGH CBS SET – TOY BREEDS AND CAT – ITEM LIST

Micro/High CBS Set – Toy Breeds and Cat		
Item No.	Description	Quantity
191465	Complete set, consisting of:	
191466	Module for CBS Toy Breeds and Cat Instruments and Screws, without instruments and screws, with cover	1
185782	Twist Drill, Ø 1.8 mm, cannulated, Ø cannulation 1.1 mm, AO Quick Coupling	1
185783	Twist Drill, Ø 2.2 mm, cannulated, Ø cannulation 1.1 mm, AO Quick Coupling	1
185670	Screwdriver Blade, Torx 6, cannulated, AO Quick Coupling	1
191361	Screwdriver Blade, Torx 8, cannulated, AO Quick Coupling	1
185192	Head Reamer, for Ø 3.0 Micro CBS, cannulated, round shaft	1
185193	Head Reamer, for Ø 4.0 High CBS, cannulated, round shaft	1
185109	KIRSCHNER Wire, Ø 1.1 x L 150 mm, trocar/blunt, round shaft	5
191391	Micro Titanium Compression Screw, Ø 3.0 x L 14 mm, cannulated, magenta, Torx 6, self-drilling, self-tapping	1
191392	Micro Titanium Compression Screw, Ø 3.0 x L 16 mm, cannulated, magenta, Torx 6, self-drilling, self-tapping	1
191393	Micro Titanium Compression Screw, Ø 3.0 x L 18 mm, cannulated, magenta, Torx 6, self-drilling, self-tapping	1
191394	Micro Titanium Compression Screw, Ø 3.0 x L 20 mm, cannulated, magenta, Torx 6, self-drilling, self-tapping	1
191303	High Titanium Compression Screw, Ø 4.0 x L 14 mm, cannulated, silver, Torx 8, self-drilling, self-tapping	1
191304	High Titanium Compression Screw, Ø 4.0 x L 16 mm, cannulated, silver, Torx 8, self-drilling, self-tapping	1
191305	High Titanium Compression Screw, Ø 4.0 x L 18 mm, cannulated, silver, Torx 8, self-drilling, self-tapping	1
191306	High Titanium Compression Screw, Ø 4.0 x L 20 mm, cannulated, silver, Torx 8, self-drilling, self-tapping	1
191307	High Titanium Compression Screw, Ø 4.0 x L 22 mm, cannulated, silver, Torx 8, self-drilling, self-tapping	1



191465

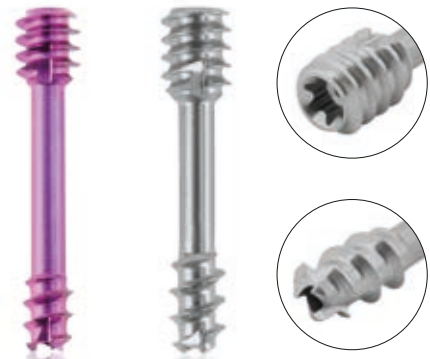

191392

191304

Optional Accessories		
Item No.	Description	Quantity
191389	Micro Titanium Compression Screw, Ø 3.0 x L 10 mm, cannulated, magenta, Torx 6, self-drilling, self-tapping	1
191390	Micro Titanium Compression Screw, Ø 3.0 x L 12 mm, cannulated, magenta, Torx 6, self-drilling, self-tapping	1
191395	Micro Titanium Compression Screw, Ø 3.0 x L 22 mm, cannulated, magenta, Torx 6, self-drilling, self-tapping	1
191396	Micro Titanium Compression Screw, Ø 3.0 x L 24 mm, cannulated, magenta, Torx 6, self-drilling, self-tapping	1
191397	Micro Titanium Compression Screw, Ø 3.0 x L 26 mm, cannulated, magenta, Torx 6, self-drilling, self-tapping	1
191398	Micro Titanium Compression Screw, Ø 3.0 x L 28 mm, cannulated, magenta, Torx 6, self-drilling, self-tapping	1
191399	Micro Titanium Compression Screw, Ø 3.0 x L 30 mm, cannulated, magenta, Torx 6, self-drilling, self-tapping	1
191301	High Titanium Compression Screw, Ø 4.0 x L 10 mm, cannulated, silver, Torx 8, self-drilling, self-tapping	1
191302	High Titanium Compression Screw, Ø 4.0 x L 12 mm, cannulated, silver, Torx 8, self-drilling, self-tapping	1
191308	High Titanium Compression Screw, Ø 4.0 x L 24 mm, cannulated, silver, Torx 8, self-drilling, self-tapping	1
191309	High Titanium Compression Screw, Ø 4.0 x L 26 mm, cannulated, silver, Torx 8, self-drilling, self-tapping	1
191310	High Titanium Compression Screw, Ø 4.0 x L 28 mm, cannulated, silver, Torx 8, self-drilling, self-tapping	1
191300	High Titanium Compression Screw, Ø 4.0 x L 30 mm, cannulated, silver, Torx 8, self-drilling, self-tapping	1

## 4.5 MM CBS SET – DOG SMALL – ITEM LIST

4.5 mm CBS Set – Dog Small		
Item No.	Description	Quantity
191470	Complete set, consisting of:	
191471	Module for CBS Dog Small Instruments and Screws Ø 4.5 mm, without instruments and screws, with cover	1
185784	Twist Drill, Ø 2.8 mm, cannulated, Ø cannulation 1.5 mm, AO Quick Coupling	1
185671	Screwdriver Blade, Torx 10, cannulated, AO Quick Coupling	1
185194	Head Reamer, for Ø 4.5 CBS, cannulated, round shaft	1
185114	KIRSCHNER Wire, Ø 1.4 x L 150 mm, trocar/blunt, round shaft	5
191414	Titanium Compression Screw, Ø 4.5 x L 28 mm, cannulated, green, Torx 10, self-drilling, self-tapping	1
191415	Titanium Compression Screw, Ø 4.5 x L 30 mm, cannulated, green, Torx 10, self-drilling, self-tapping	1
191416	Titanium Compression Screw, Ø 4.5 x L 32 mm, cannulated, green, Torx 10, self-drilling, self-tapping	1
191417	Titanium Compression Screw, Ø 4.5 x L 34 mm, cannulated, green, Torx 10, self-drilling, self-tapping	1
191418	Titanium Compression Screw, Ø 4.5 x L 36 mm, cannulated, green, Torx 10, self-drilling, self-tapping	1
191419	Titanium Compression Screw, Ø 4.5 x L 38 mm, cannulated, green, Torx 10, self-drilling, self-tapping	1
191420	Titanium Compression Screw, Ø 4.5 x L 40 mm, cannulated, green, Torx 10, self-drilling, self-tapping	1



191470



191414

Optional Accessories		
Item No.	Description	Quantity
191410	Titanium Compression Screw, Ø 4.5 x L 20 mm, cannulated, green, Torx 10, self-drilling, self-tapping	1
191411	Titanium Compression Screw, Ø 4.5 x L 22 mm, cannulated, green, Torx 10, self-drilling, self-tapping	1
191412	Titanium Compression Screw, Ø 4.5 x L 24 mm, cannulated, green, Torx 10, self-drilling, self-tapping	1
191413	Titanium Compression Screw, Ø 4.5 x L 26 mm, cannulated, green, Torx 10, self-drilling, self-tapping	1
191421	Titanium Compression Screw, Ø 4.5 x L 45 mm, cannulated, green, Torx 10, self-drilling, self-tapping	1
191422	Titanium Compression Screw, Ø 4.5 x L 50 mm, cannulated, green, Torx 10, self-drilling, self-tapping	1
191423	Titanium Compression Screw, Ø 4.5 x L 55 mm, cannulated, green, Torx 10, self-drilling, self-tapping	1
191424	Titanium Compression Screw, Ø 4.5 x L 60 mm, cannulated, green, Torx 10, self-drilling, self-tapping	1

## 5.5 MM CBS SET – DOG MEDIUM – ITEM LIST

5.5 mm CBS Set – Dog Medium		
Item No.	Description	Quantity
191475	Complete set, consisting of:	
191476	Module for CBS Dog Medium Instruments and Screws Ø 5.5 mm, without instruments and screws, with cover	1
185787	Twist Drill, Ø 3.5 mm, cannulated, Ø cannulation 1.5 mm, AO Quick Coupling	1
185115	Screwdriver Blade, Torx 15, cannulated, AO Quick Coupling	1
185195	Head Reamer, for Ø 5.5 CBS, cannulated, round shaft	1
185114	KIRSCHNER Wire, Ø 1.4 x L 150 mm, trocar/blunt, round shaft	5
191434	Titanium Compression Screw, Ø 5.5 x L 32 mm, cannulated, light blue, Torx 15, self-drilling, self-tapping	1
191435	Titanium Compression Screw, Ø 5.5 x L 34 mm, cannulated, light blue, Torx 15, self-drilling, self-tapping	1
191436	Titanium Compression Screw, Ø 5.5 x L 36 mm, cannulated, light blue, Torx 15, self-drilling, self-tapping	1
191437	Titanium Compression Screw, Ø 5.5 x L 38 mm, cannulated, light blue, Torx 15, self-drilling, self-tapping	1



191475

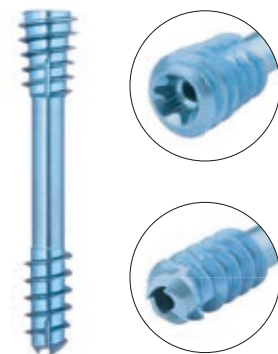

191434

Optional Accessories		
Item No.	Description	Quantity
191430	Titanium Compression Screw, Ø 5.5 x L 24 mm, cannulated, light blue, Torx 15, self-drilling, self-tapping	1
191431	Titanium Compression Screw, Ø 5.5 x L 26 mm, cannulated, light blue, Torx 15, self-drilling, self-tapping	1
191432	Titanium Compression Screw, Ø 5.5 x L 28 mm, cannulated, light blue, Torx 15, self-drilling, self-tapping	1
191433	Titanium Compression Screw, Ø 5.5 x L 30 mm, cannulated, light blue, Torx 15, self-drilling, self-tapping	1
191438	Titanium Compression Screw, Ø 5.5 x L 40 mm, cannulated, light blue, Torx 15, self-drilling, self-tapping	1
191439	Titanium Compression Screw, Ø 5.5 x L 45 mm, cannulated, light blue, Torx 15, self-drilling, self-tapping	1
191440	Titanium Compression Screw, Ø 5.5 x L 50 mm, cannulated, light blue, Torx 15, self-drilling, self-tapping	1
191441	Titanium Compression Screw, Ø 5.5 x L 55 mm, cannulated, light blue, Torx 15, self-drilling, self-tapping	1
191442	Titanium Compression Screw, Ø 5.5 x L 60 mm, cannulated, light blue, Torx 15, self-drilling, self-tapping	1

## 6.5 MM CBS SET – DOG LARGE – ITEM LIST

6.5 mm CBS Set – Dog Large		
Item No.	Description	Quantity
191480	Complete set, consisting of:	
191481	Module for CBS Dog Large Instruments and Screws Ø 6.5 mm, without instruments and screws, with cover	1
185786	Twist Drill, Ø 4.0 mm, cannulated, Ø cannulation 1.5 mm, AO Quick Coupling	1
185115	Screwdriver Blade, Torx 15, cannulated, AO Quick Coupling	1
185796	Head Reamer, for Ø 6.5 CBS, cannulated, round shaft	1
185114	KIRSCHNER Wire, Ø 1.4 x L 150 mm, trocar/blunt, round shaft	5
191455	Titanium Compression Screw, Ø 6.5 x L 36 mm, cannulated, gold, Torx 15, self-drilling, self-tapping	1
191456	Titanium Compression Screw, Ø 6.5 x L 38 mm, cannulated, gold, Torx 15, self-drilling, self-tapping	1
191457	Titanium Compression Screw, Ø 6.5 x L 40 mm, cannulated, gold, Torx 15, self-drilling, self-tapping	1
191458	Titanium Compression Screw, Ø 6.5 x L 45 mm, cannulated, gold, Torx 15, self-drilling, self-tapping	1
191459	Titanium Compression Screw, Ø 6.5 x L 50 mm, cannulated, gold, Torx 15, self-drilling, self-tapping	1



191480



191455

Optional Accessories		
Item No.	Description	Quantity
191450	Titanium Compression Screw, Ø 6.5 x L 26 mm, cannulated, gold, Torx 15, self-drilling, self-tapping	1
191451	Titanium Compression Screw, Ø 6.5 x L 28 mm, cannulated, gold, Torx 15, self-drilling, self-tapping	1
191452	Titanium Compression Screw, Ø 6.5 x L 30 mm, cannulated, gold, Torx 15, self-drilling, self-tapping	1
191453	Titanium Compression Screw, Ø 6.5 x L 32 mm, cannulated, gold, Torx 15, self-drilling, self-tapping	1
191454	Titanium Compression Screw, Ø 6.5 x L 34 mm, cannulated, gold, Torx 15, self-drilling, self-tapping	1
191460	Titanium Compression Screw, Ø 6.5 x L 55 mm, cannulated, gold, Torx 15, self-drilling, self-tapping	1
191461	Titanium Compression Screw, Ø 6.5 x L 60 mm, cannulated, gold, Torx 15, self-drilling, self-tapping	1

## Case Report 1

Andreas Käsa, Lörrach, Germany, March 17th, 2017

Yorkshire Terrier, 2.2 kg, High Titanium Compression Screw, Ø 4.0 x L 18 mm

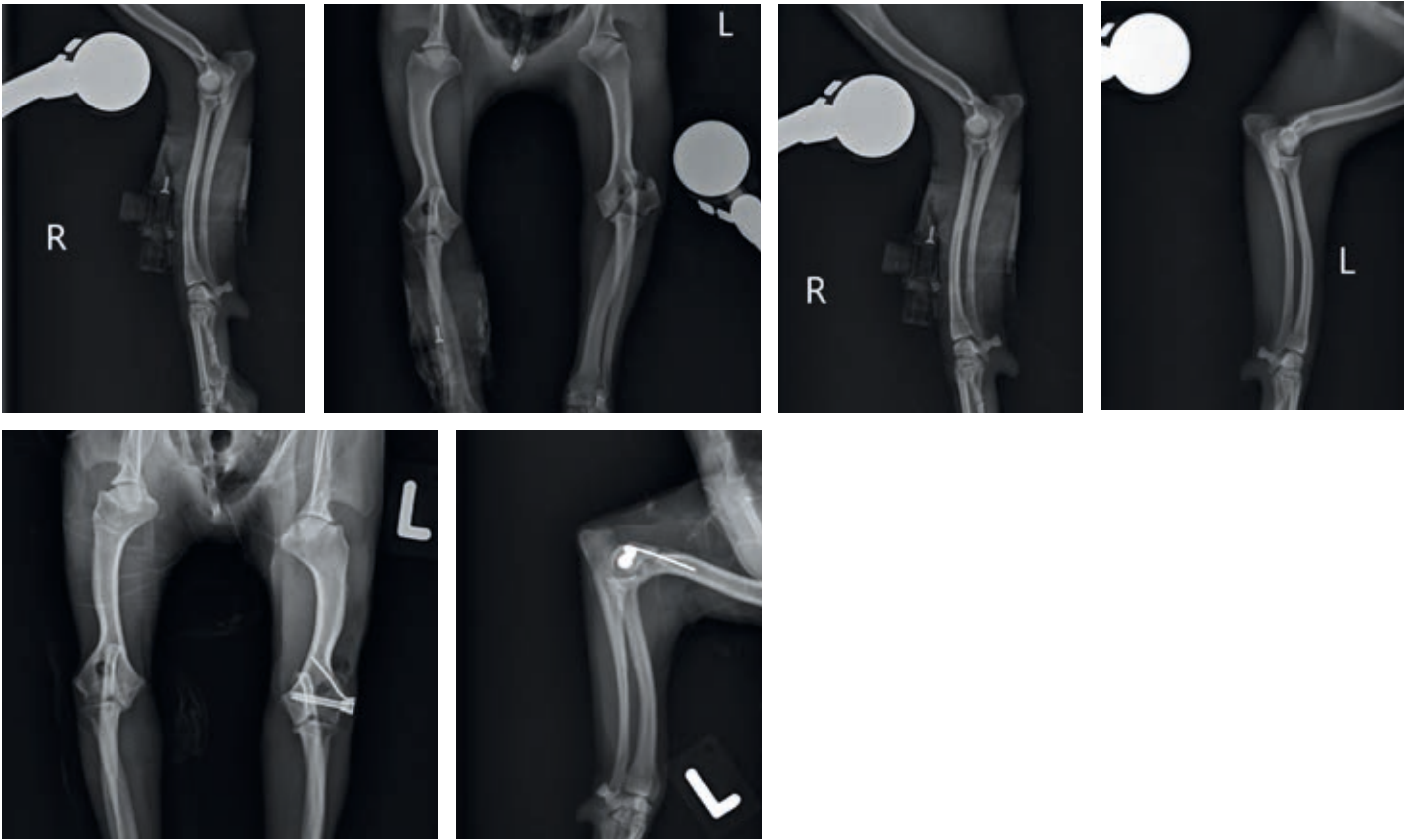

## Case Report 2

Diane Meiler, Haar, Germany, February 11th, 2017

Australian Shepherd "Maybe", transcondylar lag screw due to IOHC on the right, High Titanium Compression Screw, Ø 4.0 x L 34 mm

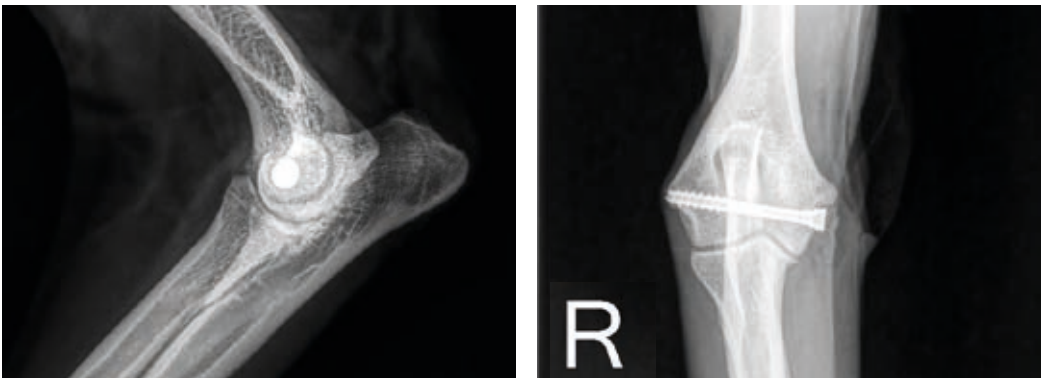

## Case Report 3

**Daniel Koch**, Diessenhofen, Switzerland, December 22nd, 2017  
Acetabulum, High Titanium Compression Screw



## Case Report 4

**Lena von Spiessen**, Aarau, Switzerland, August 3rd, 2018  
Tarsus and Carpus, Micro Titanium Compression Screw, Ø 3.0 mm



### Case Report 5

Shane Guerin, Cork, Ireland, May 30th, 2020

Femoral neck fracture repair with the 5.5 mm CBS set.

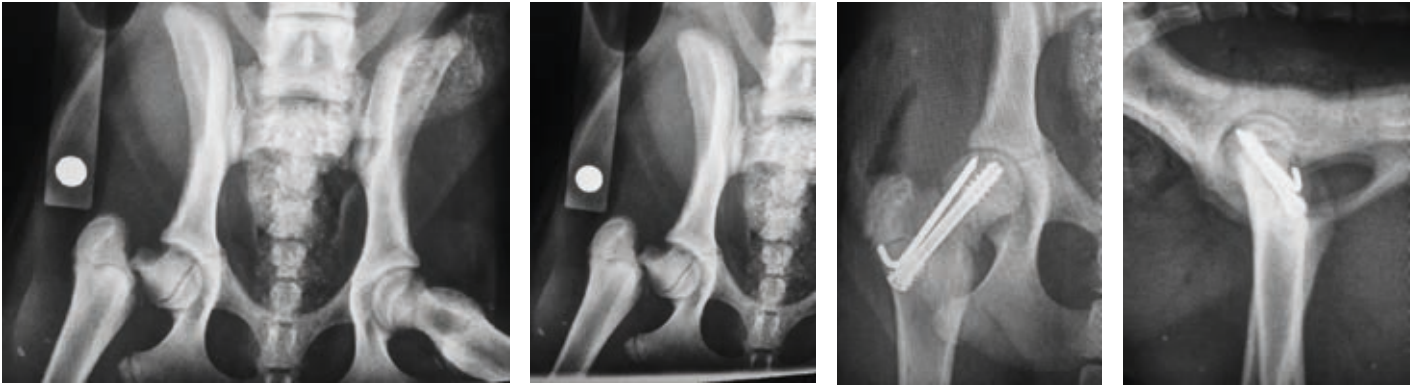

### Case Report 6

Shane Guerin, Cork, Ireland, August 13th, 2020

Traumatic fracture of the anconeal process of the elbow; repaired with 4.5 mm CBS set and two KIRSCHNER wires.

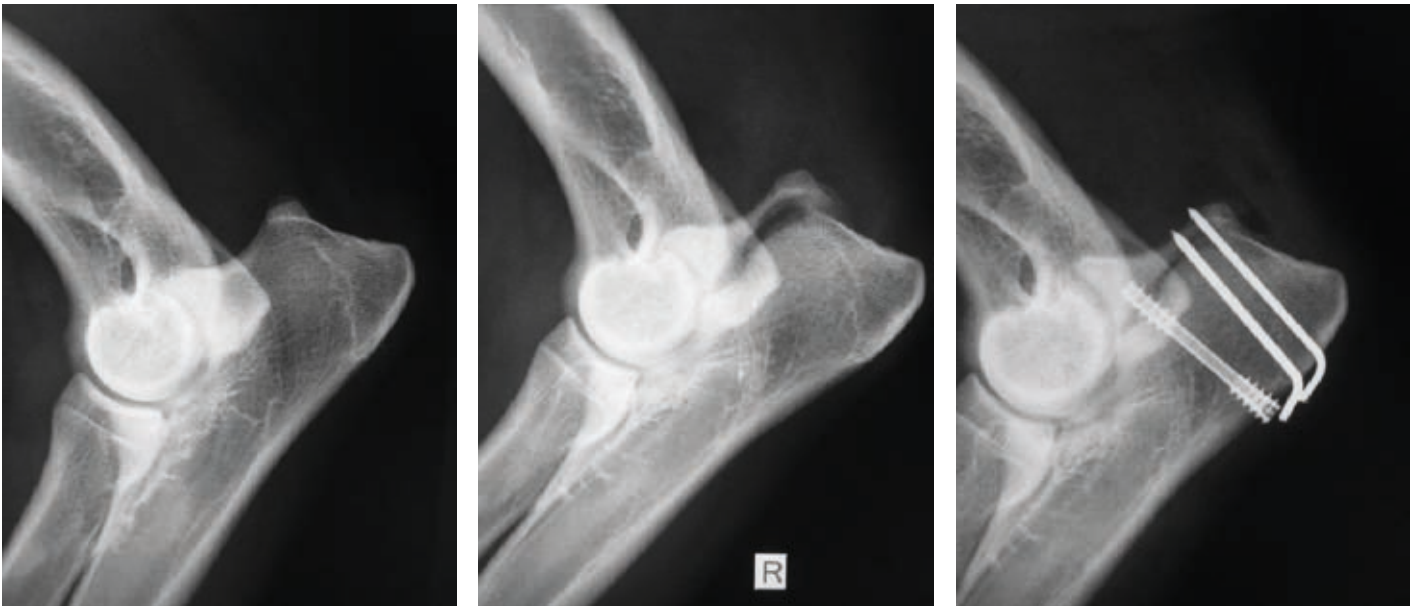

# X-RAY

## HiRay 30

*Stationary high-frequency X-Ray unit  
with the latest digital X-Ray technology*

*Amazing  
simplicity*

*Proven  
reliability*



**GO ONLINE NOW TO FIND OUT MORE**  
[www.eickemeyer.com/radiography/x-ray-machines](http://www.eickemeyer.com/radiography/x-ray-machines)



# EICKEMEYER® PinCube, PinPositioner and Pins

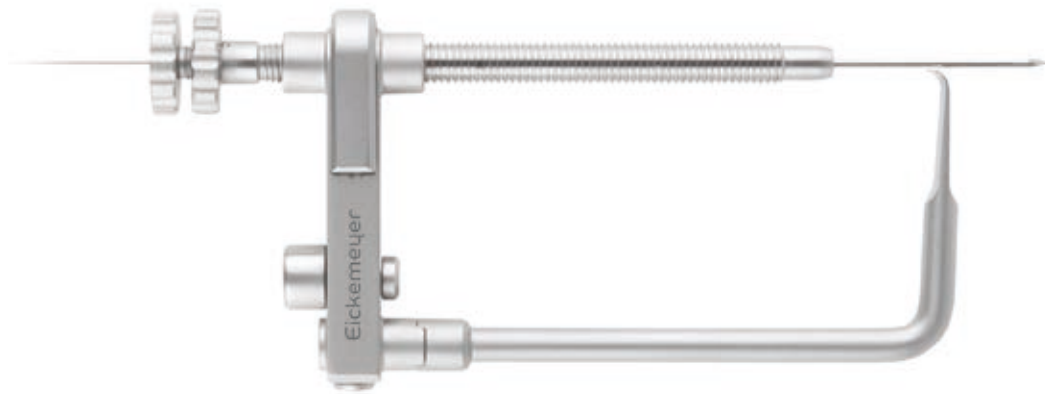

## EICKEMEYER® PINCUBE – CHARACTERISTICS

---

### Precision tool for support in osteosynthesis

As part of an osteosynthesis procedure, bone and bone fragments are fixed for mutual stabilisation. This is usually done with plates, screws, tension bands and/or rods. For some applications, such as tension band wiring, it is recommended that K-Wires are positioned parallel to each other. This is challenging to do accurately by hand.

For this reason, EICKEMEYER® has developed the PinCube!

### Advantages

- ▶ Enables K-Wires to be positioned exactly parallel
- ▶ Unique spiral-shaped hole pattern allows pins to be set at both different distances and with different diameters
- ▶ Usage of pins, drills and thread cutters in diameters of 0.6–2.0 mm
- ▶ Extremely compact dimensions: 35 mm
- ▶ Very practical tool for small animal surgery

**191348**



## EICKEMEYER® PINPOSITIONER – CHARACTERISTICS

### Precise pin positioning

As part of an osteosynthesis procedure, bone and bone fragments are fixed for mutual stabilisation. This is frequently done with K-Wires. The PinPositioner is a targeting aid to position K-Wires. It allows the user to accurately guide the K-Wires through drill sleeves in the desired direction and inclination. The PinPositioner is suitable for small animals weighing up to 20 kg.

### Advantages

- ▶ Three drill sleeves with inner diameters of 1.1 mm, 2.3 mm and 3.0 mm for drill wires
- ▶ Self-retaining fixation is possible at angles between 45° and 135°
- ▶ Due to the small, handy format of the PinPositioner (80 mm x 44 mm), the drill wire can be placed freehand at even more acute angles.
- ▶ Controlled compression is possible by rotating the drill sleeve with a fixed PinPositioner. One revolution corresponds to 1.0 mm feed.
- ▶ The direction and planned inclination of the K-Wire position can be checked by aiming over the straight arm before the K-Wire is screwed in.

### PinPositioner includes

- ▶ PinPositioner Fast Lock (191371)
- ▶ PinPositioner S L-Arm (191372)
- ▶ Drill Sleeves (Inner Ø): 1 x 3.0 mm (191373)
- ▶ Drill Sleeves (Inner Ø): 1 x 2.3 mm (191374)
- ▶ Drill Sleeves (Inner Ø): 1 x 1.1 mm (191375)

### 191370

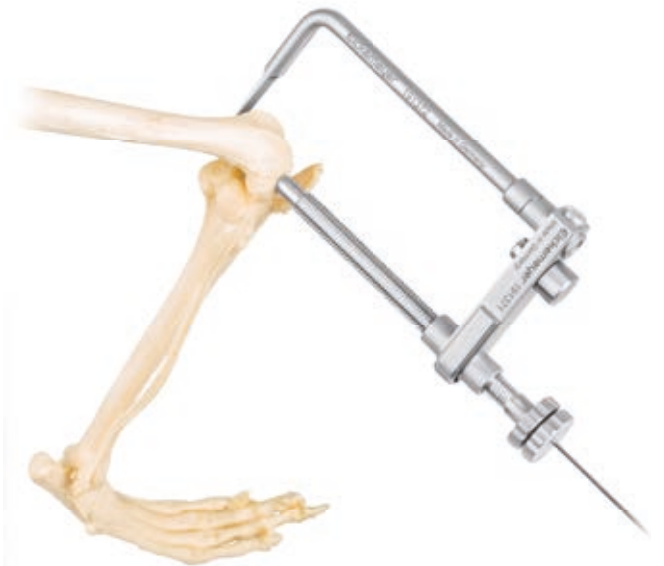
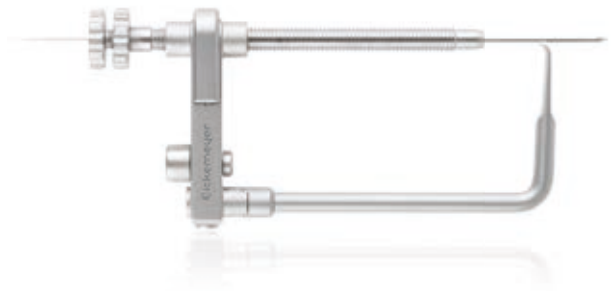

## EICKEMEYER® PINPOSITIONER – ITEM LIST

PinPositioner		
Item No.	Description	Quantity
191370	Complete set, consisting of:	
191371	PinPositioner Fast Lock	1
191372	PinPositioner S L-Arm	1
191373	Drill Sleeves (Inner Ø): 1 x 3.0 mm	1
191374	Drill Sleeves (Inner Ø): 1 x 2.3 mm	1
191375	Drill Sleeves (Inner Ø): 1 x 1.1 mm	1

# K WIRES, PINS, TOOLS AND STEINMANN NAILS – ITEM LIST

K-Wires, STEINMANN Pins and Tools		
Item No.	Description	Quantity
180758	KIRSCHNER Wire, Ø 0.8 x L 160 mm, double ended trocar	10
180760	KIRSCHNER Wire, Ø 1.0 x L 160 mm, double ended trocar	10
180762	KIRSCHNER Wire, Ø 1.2 x L 160 mm, double ended trocar	10
180764	KIRSCHNER Wire, Ø 1.4 x L 160 mm, double ended trocar	10
180766	KIRSCHNER Wire, Ø 1.6 x L 160 mm, double ended trocar	10
180768	KIRSCHNER Wire, Ø 1.8 x L 160 mm, double ended trocar	10
180770	KIRSCHNER Wire, Ø 2.0 x L 160 mm, double ended trocar	10
180780	KIRSCHNER Wire, Ø 3.0 x L 160 mm, double ended trocar	10
185109	KIRSCHNER Wire, Ø 1.1 x L 150 mm, round shaft, trocar / blunt	5
185114	KIRSCHNER Wire, Ø 1.4 x L 150 mm, round shaft, trocar / blunt	5
185516	Plate Positioning Pin, 1.4 x L 63 mm	4
180501	STEINMANN Positive Profile Pin, Ø 0.9 x L 75 mm, end thread	1
180502	STEINMANN Positive Profile Pin, Ø 1.2 x L 75 mm, end thread	1
180574	STEINMANN Positive Profile Pin, Ø 1.2 x L 100 mm, end thread	1
180572	STEINMANN Positive Profile Pin, Ø 1.5 x L 100 mm, end thread	1
180503	STEINMANN Positive Profile Pin, Ø 1.6 x L 75 mm, end thread	1
180593	STEINMANN Positive Profile Pin, Ø 2.0 x L 97 mm, end thread	1
180496	STEINMANN Positive Profile Pin, Ø 2.4 x L 102 mm, end thread	1
180493	STEINMANN Positive Profile Pin, Ø 2.8 x L 110 mm, end thread	1
180595	STEINMANN Positive Profile Pin, Ø 3.0 x L 110 mm, end thread	1
180497	STEINMANN Positive Profile Pin, Ø 3.2 x L 116 mm, end thread	1
191519	KIRSCHNER Wire, Ø 1.0 x L 190 mm, trocar/trocar	2
191520	KIRSCHNER Wire, Ø 2.0 x L 190 mm, blunt/blunt	2
191521	KIRSCHNER Wire, Ø 1.0 x L 190 mm, trocar/trocar	10
191522	KIRSCHNER Wire, Ø 2.0 x L 190 mm, blunt / blunt	10
180500	V-slot Template, for measuring K-Wires Ø 0.6 – 2.5 mm and screw lengths 3 – 45 mm	1

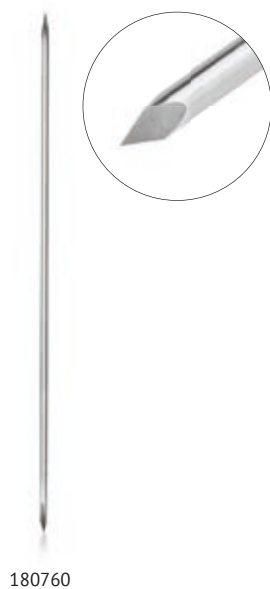

## Case Report

Hamish R. Denny, Bristol, UK, May 2nd, 2019

11 month old cat with fracture separation of the proximal humeral epiphysis, fixed using 2 K-Wires introduced through PinCube



# Normograde stabilisation

using a PinCube, PinPositioner and K-Wires

Introduction:

Proximal femur fractures account for about one-seventh of all femoral fractures in cats and dogs.

## 1. Anatomy

In dogs and cats, the femoral neck connecting the hemispherical femoral head with the femoral diaphysis is much shorter in comparison to people. The greater trochanter is positioned on the proximal lateral aspect of the femur and is connected to the neck by the deep trochanteric fossa. The femoral neck flattens in the direction of the greater trochanter and its diameter reduces by approximately 30 to 50%. Therefore, the neck region available for implant positioning is rather limited (Fig. 1).

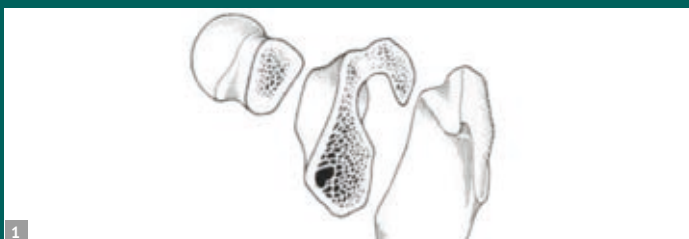

Fig.1: Cross section of the Collum ossis femoris in the basal and subcapital region

## 2. Diagnostics

The clinical symptoms are nonspecific. As a rule, there is moderate to severe lameness. Like craniodorsal hip luxations, dorsal positioning of the greater trochanter may be already obvious upon visual inspection. Upon passive range of motion of the hip joint, pain can be always observed, while crepitation is not always detectable. An X-Ray examination is therefore indispensable. In general, ventrodorsal radiographic pelvic views are more informative than lateral views. When epi- and apophyses are only slightly displaced, the fracture may not be visible when the limb is extended and internally rotated for radiographic positioning. Therefore, occasionally multiple ventrodorsal pelvic views with differing obliquities are required for diagnosis.

## 3. Therapy

Considering the special anatomical and pathophysiological aspects of proximal femoral fractures, the following treatment recommendations are made:

1. Early intervention
2. Appropriate approach and careful soft tissue handling
3. Anatomically correct reduction
4. Antirotational stabilisation that does not injure the physis ►

## 4. Surgical approach

A craniolateral approach to the hip joint is recommended. Exceptions are comminuted caput fractures, chronic fractures with apple coring of the femoral neck, fractures that do not allow to assess correct positioning at the cranial aspect of the fracture, and concomitant acetabular fractures.

Lateral positioning of the patient is recommended. A tape placed in a cranio-caudal direction in the inguinal region is used for further stabilisation, while the operated limb is supported with a pad (Fig.2).

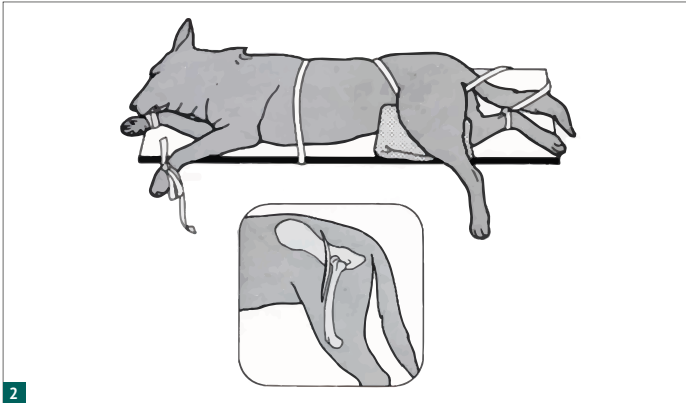

Fig. 2: Positioning of the patient

A curved incision starting cranioproximal to the greater trochanter was extended distally to the middia-physeal level following the cranial aspect of the femur. The superficial fascia, interfascial fat and deep fascia are transected following the same incision along the cranial border of the M. biceps femoris. The muscles are retracted. Then, the superficial and deep layers of the fascia lata are incised and the underlying vastus lateralis muscle can be visualised. The incision is extended along the caudo-proximal border of the tensor fasciae latae muscle. The muscle is then retracted in a cranial direction. The gluteal muscles are retracted dorsally with a handheld retractor to allow for visualisation of the hip joint. Fat superimposed over the joint capsule is bluntly dissected, taking care to preserve the vascular branches of the circumflex lateral femoral artery and vein. The origin of the vastus lateralis and intermedius muscles is elevated and retracted distally to improve exposure. Reduction forceps are placed in the subtrochanteric region to immobilize the distal fragment. Then the joint capsule is incised parallel to the long axis of the femoral neck. For this purpose, the caudolateral portion of the vastus lateralis muscle is released subperiostally. The proximal fragment is supported with a FREER periosteal elevator inserted between the acetabulum and the femoral head.

## 5. Reposition

Femoral neck fractures are more challenging, as the smooth fracture surfaces tend to slip. Sometimes the proximal fragment needs to be immobilised (supported) with a FREER periosteal elevator positioned in the neck region and not behind the femoral head. It is imperative that the fracture gap is anatomically reduced at its caudal and distal aspect to prevent valgus or anteversion malpositioning. However, a minor residual gap at the proximal aspect of the fracture may be acceptable under stable mechanical

conditions (varus position). Similarly, in this situation manual fracture reduction is also preferable compared to reduction with forceps.

## Femoral head and neck fracture – normograde pinning with PinCube, PinPositioner and K-Wires

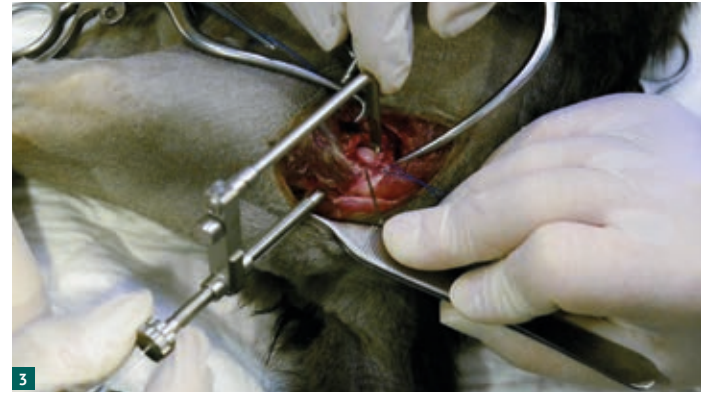

Fig. 3: PinPositioner positioned

## How to use the PinPositioner as a small aiming device

### Description of the PinPositioner:

The PinPositioner is a small target device for K-Wires, drills and taps.

### Application:

Usually, I place a small auxiliary pin at the highest point of the femoral neck just next to the calotte of the head to allow me to turn it in all directions (like a joystick). This facilitates the alignment of the head with the femoral neck.

### Handling of the PinPositioner:

Once the femoral head has been aligned with the femoral neck, the target device (PinPositioner) is assembled. The clip with double hook should be positioned medially on the femoral head at the insertion site of the femoral ligament. The drill sleeve with threads should be in contact with the trochanteric crest. The threaded sleeve can be moved back and forward in the aiming device to determine the drill direction and distance for the K wires. To advance or withdraw the threaded drill sleeve, the U-shaped clip needs to be pressed down simultaneously. This allows the drill sleeve to be pushed back and forth until the correct position is reached, in this case, at the level of the trochanteric crest.

Then, by turning the knurled end of the threaded drill sleeve in a clockwise direction, the fracture is compressed.

The assistant holds the aiming device in the set position to prevent slipping of the “clip with double hook” from the femoral head and/or of the threaded drill sleeve on the bone surface.

The threaded drill sleeve has an inner diameter of 3.0 mm. A smaller drill sleeve can be inserted and tightened at the far side. Two drill sleeves with an inner diameter of 1.1 mm and 2.3 mm are available. ►

In this way, a 1.0 mm K-Wire can be placed in a normograde fashion through the drill sleeve and exactly reaches the targeted point in the pin positioner clip with double hook.

Drilling of the K-Wire should be discontinued as soon as resistance can be felt at the trans-cortex. It is important to ensure that the pin does not protrude into the joint space. If necessary, the pin must be withdrawn.

### Removal of the aiming device:

Press the round button on the mount for the clip and drill sleeve in the direction of the drill sleeve. Simultaneously pull the “clip with the double hook” in a horizontal forward direction out of the mount. Then the clip with the double hook can be removed in an upward direction. The remaining part of the target device is slid backwards over the K-Wire.

At this point the fracture is reduced, but rotational stability is still missing.

### Use of the PinCube for parallel pin placement

A second, possibly also a third K-Wire, should be placed to achieve rotational stability. The K-Wire/s should be placed parallel to the first K-Wire. Then, according to the tension band principle, the two fracture ends are compressed by the constant pressure of the hip joint.

The PinCube is ideally suited as a parallel drilling aid.



4

Abb. 4: PinCube

### Description of the PinCube:

The PinCube is a small, compact cube with 4 sides. The spiral-shaped hole patterns on the sides of the cube have different diameters. The geometry of the corresponding holes on the opposing surfaces of the cube are identical. The size of the cube is ideally suited to allow perfect guidance for K-Wires, drills or taps that consequently results in perfect parallel alignment. The PinCube is designed to accept pins, drills and taps with an outer diameter ranging from 0.6 mm to 2.0 mm.

### How do you place the second or third K-Wire?

Push the PinCube over the K-Wire that was previously placed with the PinPositioner. You will need to find the hole with the correct diameter in the corresponding spiral (in this case the hole for 1.0 mm K-Wires). Make sure that the K-Wire exits through the exact opposite hole. The second K-Wire (usually same diameter as the first K-Wire) is now inserted into one of the adjacent holes of the same spiral. Again, make sure that the K-Wire exits through the exact opposite hole.



5

Fig. 5: Insertion of the second K-Wire into the PinCube

The distance between the K-Wires can be chosen freely. The second K-Wire is placed in the desired position. If needed the PinCube can be temporarily moved away from the bone for better visualisation of the position of the new K-Wire on the femur. The PinCube can be rotated around the first pin until the ideal position for the second pin is located on the underlying bone.

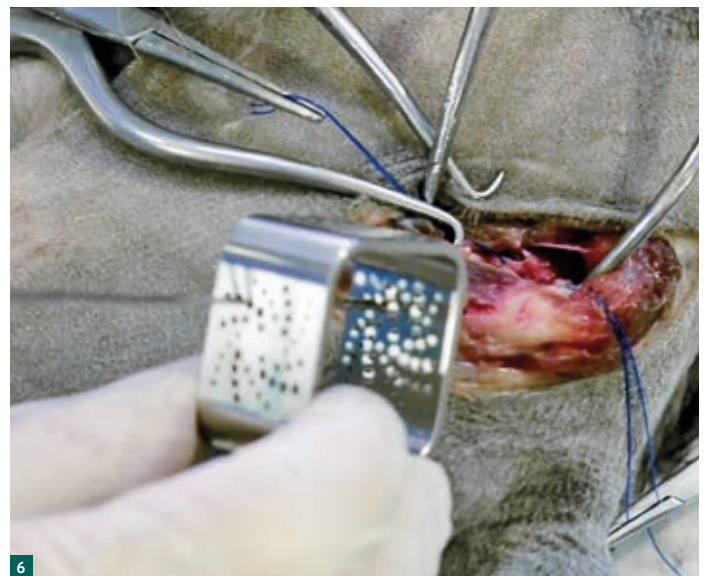

6

Fig. 6: Rotation of the PinCube

The third K-Wire is placed in a similar manner (for technique see previous pins). ▶



### Placement of the second K-Wire:

The PinCube does not necessarily need to be in contact with the surface. It should, however, be pushed there as close as possible. The first K-Wire is bent before the second can be placed.

### Removal of the PinCube:

The K-Wires are shortened and the PinCube can be removed via the ends of the K-Wires.

### Check the results:

The fracture should be anatomically reduced (no fracture gap). The femoral head is now rotated into the acetabulum, the K-Wires are cut and bent. Tagged sutures are placed into the joint capsule prior to closure. Finally, the wound is closed.

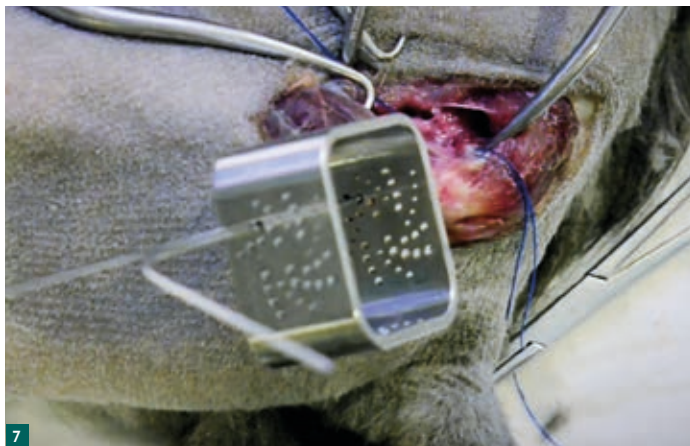

Fig. 7 Placement of the second K-Wire with help of a PinCube

---

### Result:

The desired rotational stability has been achieved. As discussed previously, the two K-Wires positioned parallel to each other, allow for compression of the fracture during weight bearing.

### Conclusion:

PinPositioner and PinCube are ideally suited to place K-Wires accurately and in a parallel fashion to each other.

### Sources:

Matis, U. und H. Waibl: Proximale Femurfrakturen bei Katze und Hund; Tierärztl. Prax. Suppl.1, 159 – 178 (1985) F. K. Schattauer Verlagsgesellschaft mbH Stuttgart – New York



### Dr. Michael Koch

Specialist Veterinary Surgeon for small animals and VETtrainer®

Studied at the University of Hanover; PhD at the LMU Munich; Resident in various veterinary clinics; Foundation of the VETtrainer® company for innovative/practical surgical 1:1 training courses; Lecturer at various surgery seminars in Germany, Austria and Switzerland

# MONITORING

## LifeVet 8

*High performance patient monitors that deliver flexibility and efficiency*

*Compact  
and portable*

*Touch screen  
operation*

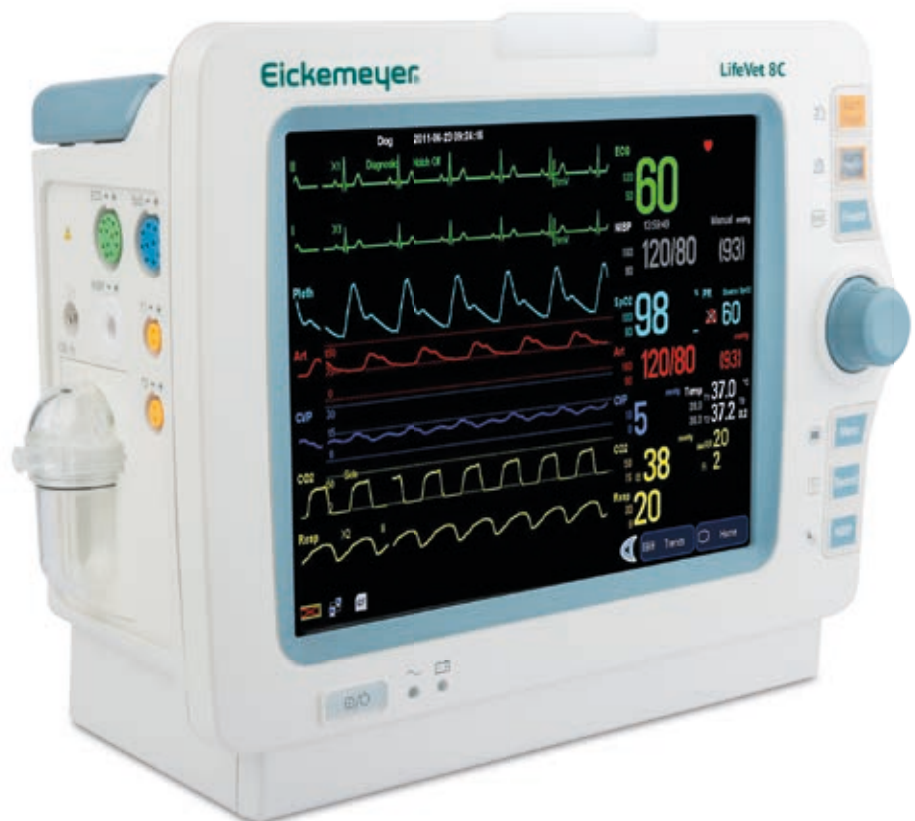

GO **ONLINE** NOW TO FIND OUT MORE

[www.eickemeyer.com/anaesthesia/anaesthesia-monitors](http://www.eickemeyer.com/anaesthesia/anaesthesia-monitors)

# MTV

## Minimally Invasive Translial Vertebral Blocking



# MTV – MINIMALLY INVASIVE TRANSILIAL VERTEBRAL BLOCKING – CHARACTERISTICS

---

The MTV implant system is an innovative procedure to successfully manage degenerative lumbosacral stenosis (DLSS).\* It has been developed by leading veterinary surgeons to help tackle this orthopaedic challenge.

## Clinical indications

Degenerative lumbosacral stenosis, neural foramen stenosis, disc protrusion, discospondylitis, and spondylosis

## Neural foramen and nerve roots

The expansion of the neural foramen to 240 %, leads to immediate decompression of the intervertebral disc

## Minimally invasive procedure

It is a straightforward and rapid surgical technique with a high success rate in many clinical cases.

## Number of clinical cases

1,000 surgeries performed to date with over a 90 % success rate speaks for itself.

\*Müller, F. & Schenk, H.C. (2014, Nov.). CT-scan assessment of the effects of minimal invasive trans-ilial vertebral blocking procedure on L7-S1 intervertebral foraminal area, endplate distance and lumbosacral angle. Abstract presented at 20th annual meeting of Federation of European Companion Animal Veterinary Associations, Munich, Germany.

**191200**

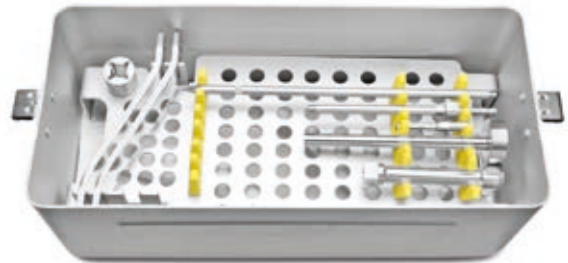
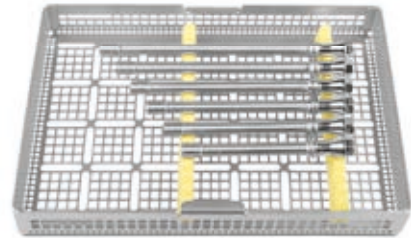

191200



191218

# MTV – MINIMALLY INVASIVE TRANSILIAL VERTEBRAL BLOCKING – SURGICAL TECHNIQUE

## Execution of the MTV using the MTV implantation set

### Steps after positioning and measurement using a C-arm:

- Step 1: Determine implant size by body weight
- Step 2: Connect the MTV drill bit with drill attachment #1
- Step 3: Incise and blunt dissect soft tissue (about 2 cm) for the insertion of the MTV drill bit into the target area
- Step 4: Insert the MTV drill bit under fluoroscopy until it penetrates the opposite body side
- Step 5: Disconnect drill attachment #1
- Step 6: Connect MTV implant with a socket wrench to drill attachment #2 and then onto the MTV drill bit, tightening with the combination wrench
- Step 7: Insert the MTV implant with gentle force until it “sits” in the correct location. Confirm location with fluoroscopy. Remove MTV drill bit and drill attachment #2 using combination wrench and locking nut
- Step 8: Close wound and confirm the implant location with X-Ray / CT

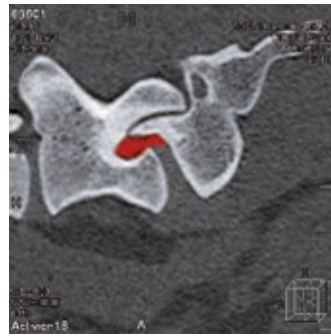

CT before MTV Implant, Neural Foramen Stenosis

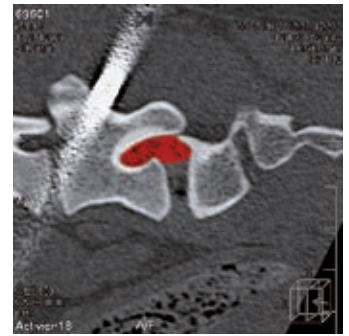

CT post MTV Implant, Neural Foramen Enlargement

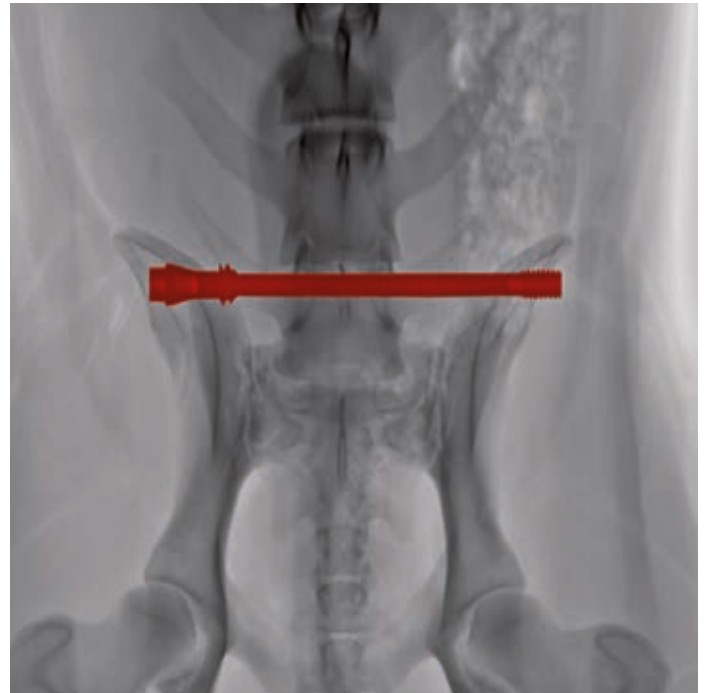

Review of the surgical outcome

## MTV – MINIMALLY INVASIVE TRANSILIAL VERTEBRAL BLOCKING – ITEM LIST

MTV Set		
Item No.	Description	Quantity
191200	Complete set, consisting of:	
191201	Drill Bit	1
191202	Drill Bit Attachment #1, AO Quick Coupling	1
191203	Drill Bit Attachment #2, AO Quick Coupling	1
191204	Socket Wrench	1
191205	Combination Wrench, pair	1
191206	Locking Nut	1
191207	Depth Gauge	1
191208	Silicone Instrument Rack	1
191209	Instrument Tray	1
191218	Implant, Ø 6 x 80 mm	1
191219	Implant, Ø 6 x 90 mm	1
191220	Implant, Ø 6 x 100 mm	2
191221	Implant, Ø 6 x 110 mm	2
191222	Implant, Ø 6 x 120 mm	2
191223	Implant, Ø 6 x 130 mm	1
500610	Base for Sterilisation Container, silver, dimensions (in cm): L 30 x W 14 x H 10	1
500700	Lid for Sterilisation Container, silver	1
18580002	Silicone Instrument Rack	3

# MTV

## *Minimal Invasive Transilial Vertebral Blocking*

- 1. Purpose and prerequisites*
- 2. Definition and management of Degenerative Lumbosacral Stenosis (DLSS)*
- 3. MTV principle*
- 4. Prospective CT study using MTV implants*
- 5. MTV – Surgical procedure and postoperative management*

### **1. Purpose and prerequisites**

MTV is a minimal invasive non-destructive method for management of lumbosacral diseases.

These diseases include, in the first instance:

- Foraminal stenoses L7 / S1
- Instability of the lumbosacral joint
- Intervertebral disc lesions L7 / S1.

Conventional surgical techniques decompress the cauda equina nerves by laminectomy or foraminotomy with targeted destruction of the vertebrae. Instability/ventral subluxation of the sacrum is corrected using screws alone (facet joints) or screws combined with bone cement or rods. MTV modifies the biomechanics of the lumbosacral joint in such a way to produce both decompression of the nervous tissue and stabilisation of L7/S1 in a single step. This combined effect is achieved by inserting the implant using intraoperative fluoroscopy and is a much less time-consuming and atraumatic alternative to conventional procedures. ►

## 2. Definition and management of DLSS

The lumbosacral transition zone is prone to a variety of diseases, especially in middle to larger dog breeds from middle age onwards. Most conditions have a degenerative aetiology (intervertebral disc degeneration, thickening of the flavum ligament, foraminal stenoses, formation of compressive spondylosis). However, in addition to traumatic and neoplastic causes, inflammation of the disc and the vertebral end plates can occur. Due to the large number of possible degenerative causes, which can also occur in combination with one another, there are also many clinical manifestations for diseases located at the transition from the lumbar spine to the os sacrum. These causes are summarised by the term, degenerative lumbosacral stenosis (DLSS) since the symptoms of the affected patients are often unspecific. The assumption that the dog has intermittent pain or a phase-like hind leg lameness are certainly the most common reasons to the veterinarian. Confirmation of DLSS can only be determined by the combination of accurate neurological examination with a sectional imaging (CT, or better MRI).

Jones and Inzana (2000) and Mayhew et al (2002) both demonstrated that even clinically normal dogs can show changes of DLSS on CT or MRI; hence, imaging alone without supporting neurological evidence can lead to an incorrect diagnosis.

In cases of clear DLSS diagnoses, primarily decompressive therapy options have been described including:

- ▶ Laminectomy L7/S1 or S1 only, possible also in combination with an annulectomy / nucleotomy
- ▶ Formaminotomy either from lateral or dorsal – facetectomy

In cases of instability at L7 – S1, (traumatic or degenerative), techniques for fixation and fusion of the vertebral bodies are used, including:

- ▶ Transarticular screws on the facet joints L7 / S1, in the pedicle of L7 and sacrum, which are connected using bone cement or a special rod-joint construction.
- ▶ Another technique for fixation of the lumbosacral joint are angled nails for connecting the processus spinosus L7 with sacrum and ilium (Slocum & Devine, 1986).



Fig. 1: Typical posture of a dog with lumbosacral pain

All these techniques are associated with a considerable soft tissue trauma associated with lateral access to the entire dorsal axial muscles. The stabilisation techniques are particularly time consuming interventions and demand considerable surgical expertise and experience.

## 3. MTV principle

The MTV was developed in 2006 based on the use of a Steinmann Pin. The basic idea was to use the mobility of the lumbosacral joint for treatment, which can also be seen as a part of the pathogenesis of DLSS. The pathological findings of a lumbar disc prolapse L7 / S1 or a foraminal stenosis are clearly visible on MRI at the transition from the lumbar spine to the os sacrum in extension i.e. with the hind legs stretched backwards.

When the MRI is repeated with the hind legs positioned forwards, the degree of intervertebral disc prolapse diminishes, while the area between the end plates widens, simultaneously providing more space for the disc material ventrally and the neuroforamina opens and show more fat signal.

In this “legs forward” position, there is more space around the cauda equina nerves, resulting in significantly less compression. ▶

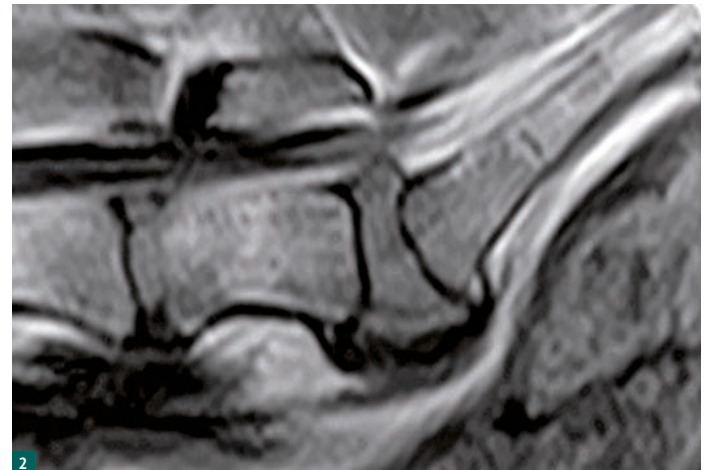

Fig. 2: Midsagittal MRI-T1 weighted cut, positioning of the lumbosacral joint in hyperextension: there is pronounced intervertebral disc protrusion at L7 / S1

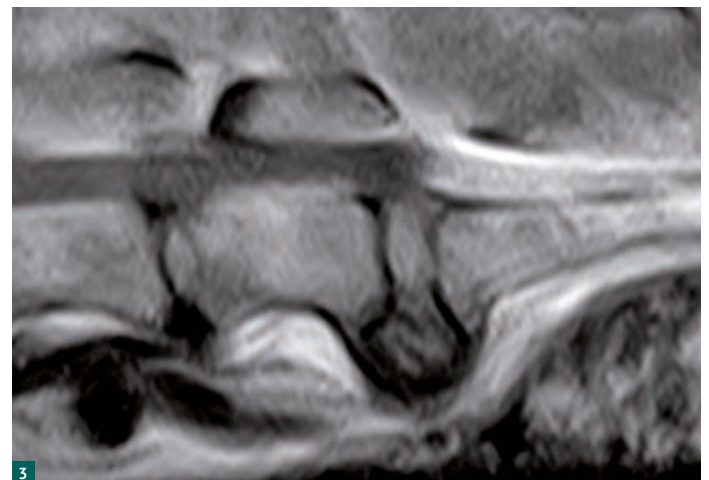

Fig. 3: Midsagittal MRI-T1 weighted cut, positioning of the lumbosacral joint in hyperflexion: the disc protrusion is decreased





Fig. 4: Parasagittal MRI-T1 weighted cut, positioning of the lumbosacral joint in hyperextension: Absent fat signal at L7 / S1 neuroforamen, Fat signal evident at the L6 / L7 neuroforamen.

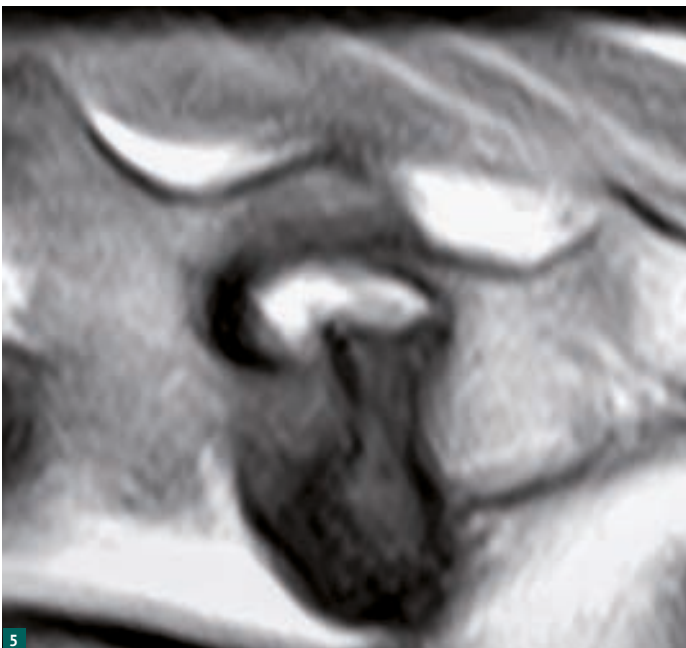

Fig. 5: Parasagittal T1 weighted cut, positioning of the lumbosacral joint in hyperflexion: Fat signal evident at L7 / S1 neuroforamen

The Steinmann Pin is inserted through both ala ossis ilii (wing of ilium) in a flexed lumbosacral joint (“legs forward” position) and positioned in the processus spinosus of L7 or caudodorsal on the arcus of L7. This allows the implant to function as a guiding device.

The lumbosacral joint cannot be over-extended even when hind legs are positioned in maximum extension (“legs back” position). The “dynamic guided” fixation in the flexed position widens the space of the neuroforamina and the intervertebral disc gap between L7/S1 more than in a neutral or extended position of the lumbosacral joint.

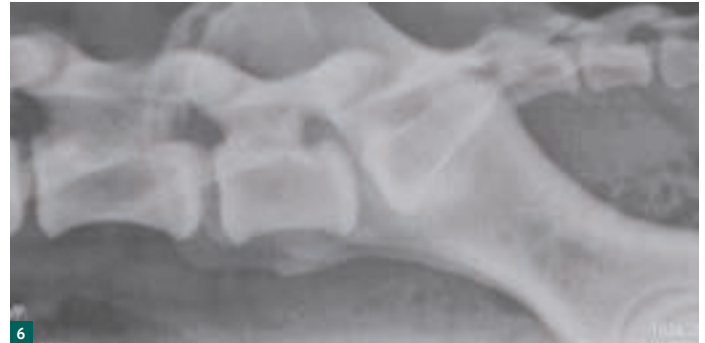

Fig. 6: Latero-lateral X-Ray of the lumbosacral spine in hyperextension



Fig. 7: Latero-lateral X-Ray of the lumbosacral spine in hyperflexion

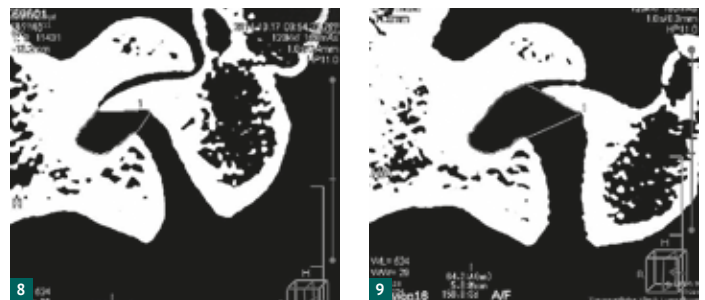

Fig. 8 and 9: Parasagittal CT scan, position of the lumbo-sacral joint in hyperextension.  
Fig. 8: Measurement of the area of the neuroforamen. Pre-op: Area content: 31.5 mm<sup>2</sup>  
Fig. 9: Measurement of the area of the neuroforamen Post-op: Area content: 64.2 mm<sup>2</sup>

#### 4. Prospective CT study using MTV implants

In a prospective CT study\* (Tierklinik Lüneburg) in 59 dogs with DLSS the transition from the lumbar spine to the os sacrum before and after the MTV implant was measured and showed that the neuroforaminal area on a defined parasagittal section was increased on average to 190 %. In addition to the increased neuroforaminal area, the endplate widening between L7 and S1 improved significantly ( $p < 0.0001$ ). CT in 12 of the 59 patients one year after surgery showed the enlargement of the neuroforaminal size and the improved lumbosacral angle were maintained compared to the preoperative situation ( $p < 0.01$ ). However, the degree of enlargement was less than directly measured after the operation (example: neuroforamen area post-op – maximum: 248 %, follow-up after 1 year – maximum: 128 %). The median measured endplate space showed no significant ( $p < 0.01$ ) widening in the control CT, while all other measured variables were still significantly greater than preoperative. From the clinical perspective all patients improved after the procedure.

## 5. MTV – Surgical procedure and postoperative management

The dorsolateral operation area is shaved and prepped routinely. The patient is positioned in sternal recumbency while hind legs are stretched forwards symmetrically and fixed with adhesive tape to avoid movement during the procedure. In this “frog leg” position the lumbosacral joint is in maximal flexion and the neuroforamens are open. The symmetric position of the vertebral column and the iliac wings is achieved under fluoroscopic guidance in latero-lateral placement by rotation of the operating table and/or the C-arm. The implant length is determined by measuring the horizontal distance of the iliac crests in ventro-dorsal position (see picture above right) at the height of the processus spinosus of L7. Preoperative implant size is measured by fluoroscopy or by X-Ray or CT and then confirmed intraoperatively using the measuring sleeve of the MTV instrumentation set. The ideal implant position is on the arcus dorsalis in the proc. spinosus between the proc. articularis caudalis and cranialis of the L7. Individual anatomical variations in the position of the L7 relative to the pelvis, e.g. in the case of transitional vertebrae, may require different positioning of the implant.

After the position has been determined, the MTV implant is inserted with the MTV Implantation Set, under fluoroscopic control following the surgical description Steps 1 to Step 9.

- Step 1: The MTV implant length is measured on the ventrodorsal radiograph of the pelvis from the left to the right cranial part of the ilial wing on an imaginary line just cranial to the spinous process of L7.
- Step 2: The Target Nail is attached to the drill – Attachment no. 1 (short). The tip of the nail is used to determine the insertion point of the implant by fluoroscopic guidance. The insertion point should be in the wing of the ilium, in the processus spinosus of L7 on the dorsal arch of L7 and cranial to the facet joint of the sacrum/L7. Changes of this insertion point can result from variations in individual anatomy.
- Step 3: The position of skin incision with muscle preparation of about 2 cm length.
- Step 4: The MTV Target Nail is inserted into the incision and advanced through the gluteal muscles to the planned target point at the ilial wing. After additional fluoroscopic guidance, the Target Nail is drilled through both ilial wings until the tip emerges through the skin on the opposite side. The MTV Gauge is placed onto the Target Nail, first on one then on the opposite side and advanced to the bone. In situ implant length controlling is also done. The distance between the nail entry point and the measuring gauge (16 cm for small dogs; 19 cm for large dogs) is read off the measuring gauge. This step is repeated on the opposite side. Both values are added and then subtracted from the entire length of the 16 or 19 cm.

### Example

*Large dog: the measured length at the nail entry point is 5 cm at the nail exit 3 cm = 8 cm. 19 cm measuring range minus measured 8 cm results in an implant length of 11 cm.*

- Step 5: The drill and attachment no. 1 (short) are removed from the nail in the dog.
- Step 6: The determined MTV implant is now screwed onto the Target Nail. The socket wrench is placed on the drill (Attachment no. 2 – long) which is then screwed together with the implant and locked with the counter wrenches at the connections. Drill attachment no. 1 is then connected to the drill.
- Step 7: Drilling is continued until the target position of the MTV Implant is reached when the Target Nail penetrates the dog’s skin on the opposite side. The Counter Wrench is placed on the socket wrench. Target Nail and Drill – Attachment no. 2 are now unbolted by drilling in anti-clockwise direction and finally removed from the implant.
- Step 8: The wound is closed routinely and the position of the implant is checked by fluoroscopy.
- Step 9: Finally, a review of the surgical outcome (degree of opening neuroforamina, vertebral end-plates distance, reduction of disc prolapse) is performed by X-Ray or preferably with CT. ▶

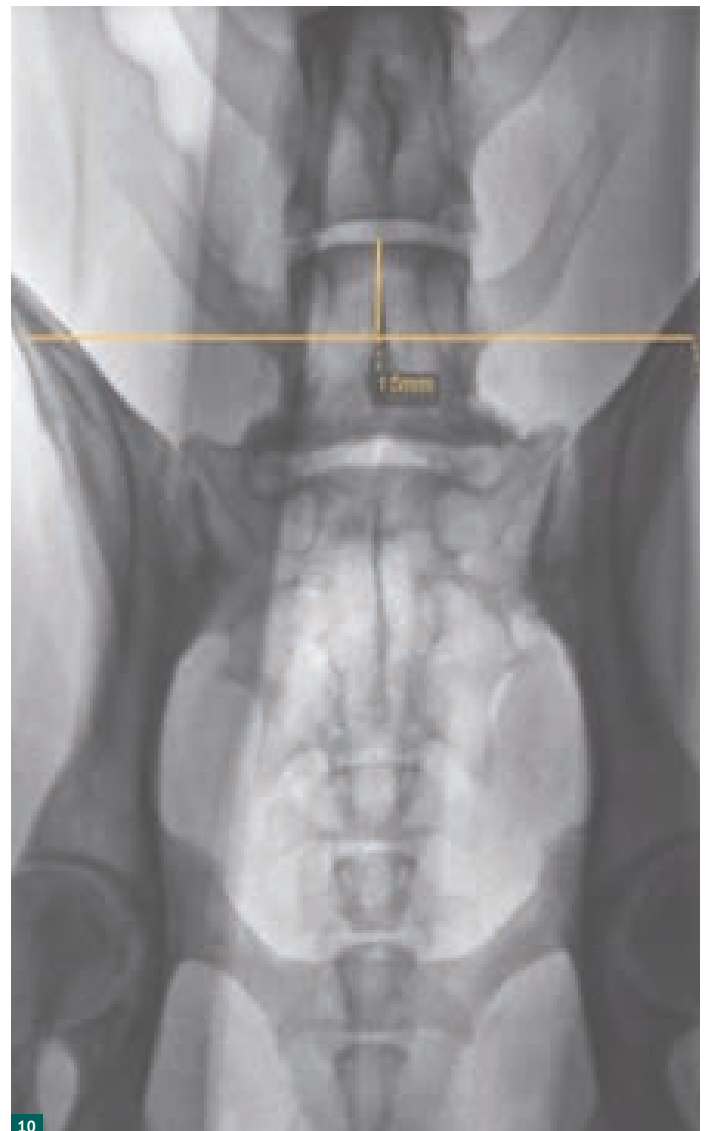
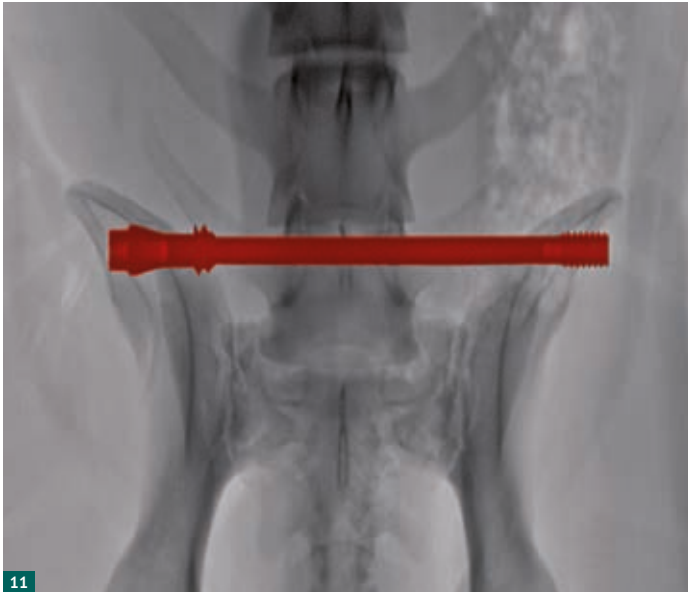

Fig. 10: Preoperative measuring of the MTV implant size



11  
Fig. 11: Review of the surgical outcome



14

### Positioning of the patient



12

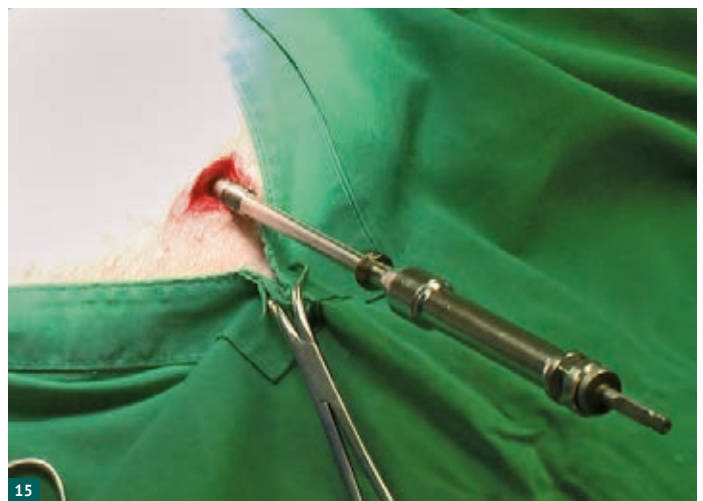

15

### Final position of the implant

### Positioning of the target nail



13

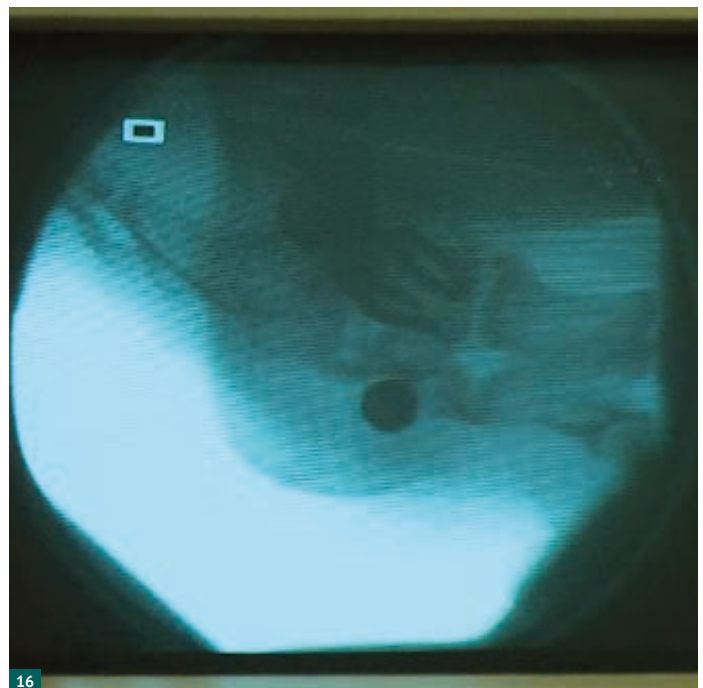

16

## Summary

## Conclusions and rehabilitation recommendation

In general, the patient can be discharged home on the same day, but at the latest by the next day.

Postoperative care includes:

- ▶ Lead rest for 3 – 4 weeks – light exercise on the lead beginning on Week 2 is recommended
- ▶ Physiotherapy is also recommended
- ▶ NSAID analgesia
- ▶ Antibiotic therapy for 5 – 7 days

The implant and its position after implantation have been documented in more than 59 cases from a total of 750 MTV surgeries. Follow-up examinations using CT and X-Ray demonstrate its stability, load-bearing properties, and the sustained improvement in the lumbosacral biomechanic function.

The MTV procedure allows clinical improvement and morphometric enlargement of foraminal area in dogs with variable amount of foraminal stenosis and seems to alleviate signs of lumbosacral pain due to disc herniations. For this reason, hunting and working dogs can return to normal function again after the appropriate convalescence.



**Dr. Friedrich Müller**

1975 – 1981 studies at Hanover University; 1982 doctorate; Founding Partner of the Veterinary Clinic Lueneburg; Official Consultant HD / ED / OCD of the Society for X-Ray diagnostics of genetic related skeletal diseases in small animals (GRSK); Focus: orthopaedics and neurosurgery.



**Dr. Henning C. Schenk**

1997–2002 studies at the Hanover University; 2005 PhD; 2004–2007 postgraduate PhD and PhD in Neuroscience; 2007–2010 Residency; 2012 Diplomate ECVN (European College of Veterinary Neurology); Further education at the Tierspital Bern (Switzerland) and UC Davis (USA); since 2011 head of neurology.

## MTV – MINIMALLY INVASIVE TRANSILIAL VERTEBRAL BLOCKING – VIDEOS

---

MTV video animation



MTV Live-OP 2014



MTV Case Study "Urri"



# Cruciate Ligament Surgery

## Extracapsular Cranial Cruciate Stabilisation

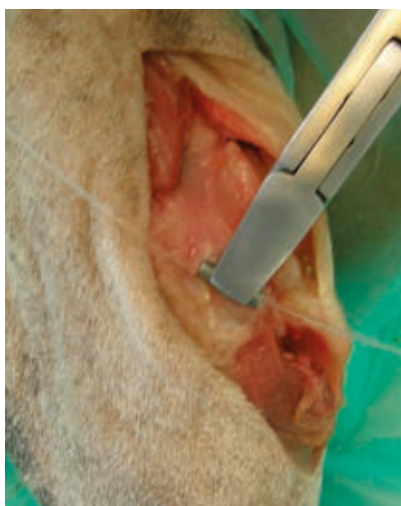
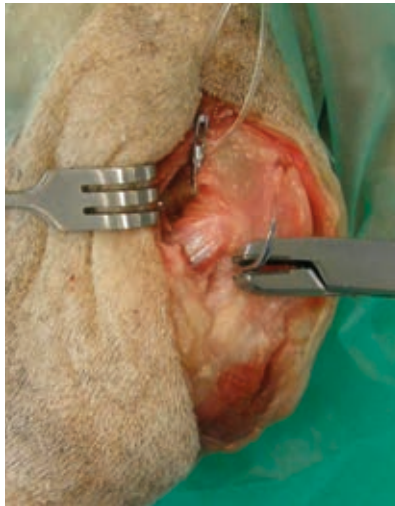

## EXTRACAPSULAR CRANIAL CRUCIATE STABILISATION – CHARACTERISTICS

One method of extracapsular stabilisation is by using a heavy nylon suture.

Heavy nylon sutures can be placed in one of two ways. The first way is to use nylon swaged on to a needle. The second way is to pass the nylon through the eye of a fabella needle. The needle with the attached nylon is passed through a pre-drilled hole in the tibial crest. It is then passed around a fabella before both ends are inserted into a metal crimper, which creates a much smaller structure compared to a knot.

The two ends of the nylon that have been passed through the metal crimping device are compressed with modified pliers to ensure adequate compression / tension.

The picture series shows the implementation of the crimp and associated crimping forceps.

This lateral technique acts as a temporary stabiliser until the dog has produced enough fibrous tissue to provide long-term joint stabilisation.

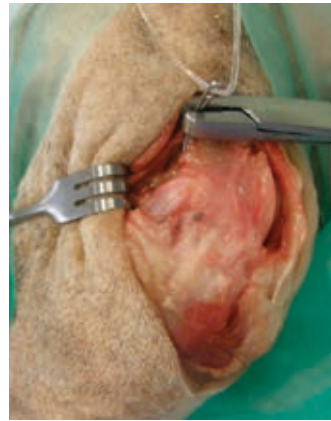

Step: 1

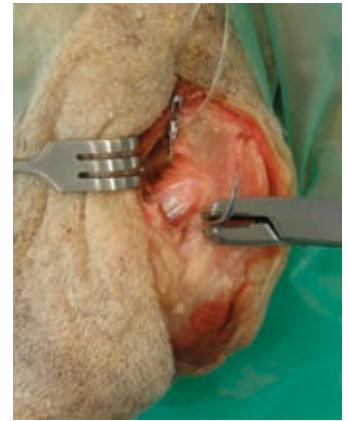

Step: 2



Step: 3



Step: 4



Step: 5

### Correct



Three evenly spaced crimps.

### Wrong



Just one crimp.



Just two crimps.



Crimp not fully pressed.



Crimps too close to the end of the tube.

# EXTRACAPSULAR CRANIAL CRUCIATE STABILISATION – ITEM LIST

## Lateral Suture System Pack

- ▶ Fabella needle is purchased separately
- ▶ Supplied in a sterile envelope

Lateral Suture System Pack	
Item No.	Description
19409501	<ul style="list-style-type: none"> <li>• 50 lb x 50 cm nylon suture</li> <li>• 1x 10 mm crimp</li> <li>• Patient weight: Up to 10 kg</li> </ul>
19409601	<ul style="list-style-type: none"> <li>• 80 lb x 80 cm nylon suture</li> <li>• 1x 12 mm crimp</li> <li>• Patient weight: Up to 20 kg</li> </ul>
19409701	<ul style="list-style-type: none"> <li>• 100 lb x 80 cm nylon suture</li> <li>• 1x 12 mm crimp</li> <li>• Patient weight: Over 20 kg</li> </ul>
194095	<ul style="list-style-type: none"> <li>• 50 lb x 50 cm nylon suture</li> <li>• 3 x 10 mm crimps</li> <li>• Patient weight: Up to 10kg</li> </ul>
194096	<ul style="list-style-type: none"> <li>• 80 lb x 80 cm nylon suture</li> <li>• 3 x 12 mm crimps</li> <li>• Patient weight: Up to 20kg</li> </ul>
194097	<ul style="list-style-type: none"> <li>• 100 lb x 80 cm nylon suture</li> <li>• 3 x 12 mm crimps</li> <li>• Patient weight: Over 20 kg</li> </ul>



19409501



194095

## Lateral Suture System Multipack I

Lateral Suture System Multipack I	
Item No.	Description
194020	Lateral Suture System Multipack I, consisting of:
19409501	Lateral Suture System Pack (Single Crimp) <ul style="list-style-type: none"> <li>• 50 lb x 50 cm nylon suture, 10 mm crimp</li> <li>• Patient weight: Up to 10 kg</li> </ul>
19409601	Lateral Suture System Pack (Single Crimp) <ul style="list-style-type: none"> <li>• 80 lb x 80 cm nylon suture, 12 mm crimp</li> <li>• Patient weight: Up to 20 kg</li> </ul>
19409701	Lateral Suture System Pack (Single Crimp) <ul style="list-style-type: none"> <li>• 100 lb x 80 cm nylon suture, 12 mm crimp</li> <li>• Patient weight: Over 20 kg</li> </ul>



194020

## Lateral Suture System Multipack II

Lateral Suture System Multipack II	
Item No.	Description
194021	Lateral Suture System Multipack II, consisting of:
194098	Lateral Suture System Pack <ul style="list-style-type: none"> <li>• 30 mm fabella needle, swaged</li> <li>• 50 lb x 50 cm nylon suture, 10 mm crimp</li> <li>• Suitable for animals up to 10 kg</li> </ul>
194099	Lateral Suture System Pack <ul style="list-style-type: none"> <li>• 45 mm fabella needle, swaged</li> <li>• 80 lb x 80 cm nylon suture, 12 mm crimp</li> <li>• Suitable for animals up to 20 kg</li> </ul>
194100	Lateral Suture System Pack <ul style="list-style-type: none"> <li>• 62 mm fabella needle, swaged</li> <li>• 100 lb x 80 cm nylon suture, 12 mm crimp</li> <li>• Suitable for animals over 20 kg</li> </ul>



194021

# EXTRACAPSULAR CRANIAL CRUCIATE STABILISATION – ITEM LIST

## Lateral Suture System Pack

Lateral Suture System Pack	
Item No.	Description
194098	30 mm fabella needle, 50 cm nylon suture, 10 mm crimp, up to 10 kg
194099	45 mm fabella needle, 80 cm nylon suture, 12 mm crimp, up to 20 kg
194100	62 mm fabella needle, 80 cm nylon suture, 12 mm crimp, over 20 kg



194098



194062

## Nylon Suture

Nylon Suture	
Item No.	Description
194062	50 cm, 10 to 15 kg
194066	80 cm, 15 to 20 kg
194070	80 cm, over 20 kg



194074

## Fabella Needle

Curved needles with an eye that are suitable for placing nylon suture to help stabilise the stifle joint.

- ▶ 6 per pack

Fabella Needle	
Item No.	Description
194074	Small
194076	Medium
194078	Large



194060

## Crimp Tubes

- ▶ Unsterile
- ▶ 10 per pack

Crimp Tubes	
Item No.	Description
194060	L 10 mm
194058	L 12 mm



194090

194091

## Crimping Forceps

Designed to compress crimp barrels to create a knot-free and smaller profile than commonly tied knots.

Crimping Forceps	
Item No.	Description
194090	L 200 mm
194091	Compound Action Crimping Forceps, delivers greater force with less hand fatigue, angled head improves visualisation, L 230 mm

## Lamina Retractor Inge

- ▶ Designed to distract the femur from the tibia to improve visualisation of the stifle joint
- ▶ One tip is inserted into the intercondylar notch and the other under the intermeniscal ligament
- ▶ Bar ratchet mechanism maintains retraction, which allows the surgeon to have both hands free
- ▶ Maximum Tip Opening: 4 mm
- ▶ Length: 170 mm

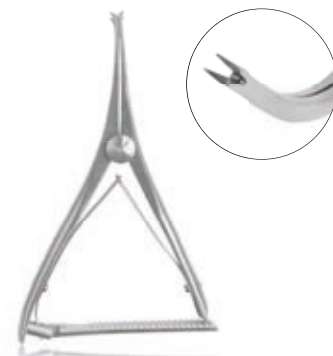

184118



## EXTRACAPSULAR CRANIAL CRUCIATE STABILISATION – ITEM LIST

### Retractor Inge

- ▶ Designed to distract the femur from the tibia to improve visualisation of the stifle joint
- ▶ One tip is inserted into the intercondylar notch and the other under the intermeniscal ligament
- ▶ Bar ratchet mechanism maintains retraction, which allows the surgeon to have both hands free
- ▶ Maximum Tip Opening: 8 mm
- ▶ Crossover Tips
- ▶ Length: 180 mm

161715



161715

### Stifle Distractor WALLACE

- ▶ Designed to improve visualisation of the stifle joint
- ▶ One tip is inserted into the intercondylar notch and the other under the intermeniscal ligament
- ▶ Self-retaining retractor allows the surgeon to have both hands free
- ▶ Crossover Tips
- ▶ Length: 100 mm

161711



161711

### Retractor GELPI

- ▶ GELPI retractors are indispensable for orthopaedic procedures
- ▶ The cam ratchet mechanism (self-locking) allows the surgeon to have both hands free
- ▶ We recommend a pair of same sized GELPIS to help maintain tissue retraction

Retractor GELPI	
Item No.	Description
161609	Sharp, L 90 mm
16160901	Blunt, L 90 mm
161611	Sharp, L 110 mm
16161101	Blunt, L 110 mm
161614	Sharp, L 140 mm
16161401	Blunt, L 140 mm
161619	Sharp, L 180 mm
16161901	Blunt, L 180 mm

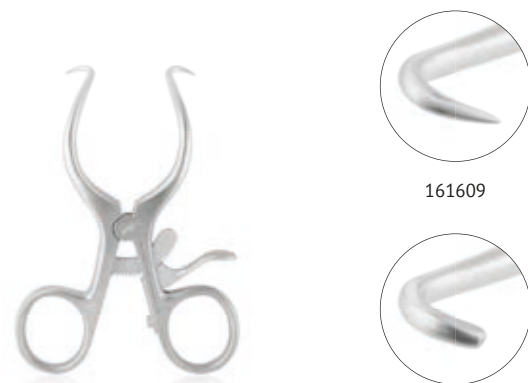

161609

16160901

### Wire Passer

- ▶ Ideal for placing wire close to the bone without damaging surrounding soft tissue
- ▶ Suitable for extracapsular cruciate repair using wire
- ▶ Single-ended
- ▶ Up to 1.0 cm orthopaedic wire
- ▶ Length: 210 mm

181521



181521

# EXTRACAPSULAR CRANIAL CRUCIATE STABILISATION – ITEM LIST

## Graft Passer

- ▶ Suitable for graft placement with an intra-articular (i.e. over the top) technique
- ▶ Curved design minimises soft tissue trauma

Graft Passer	
Item No.	Description
181520	Curved 2.0 cm, L 155 mm
181530	Curved 3.0 cm, L 165 mm
181545	Curved 4.5 cm, L 175 mm
181560	Curved 6.0 cm, L 205 mm



181520

## Lateral Suture Set – Basic

Lateral Suture Set – Basic		
Item No.	Description	Quantity
194022	Complete set, consisting of:	
194090	Crimping Forceps, L 200 mm	
194098	Lateral Suture System Pack, 30 mm fabella needle, swaged, 50 lb x 50 cm nylon suture, 10 mm crimp, up to 10 kg	2
194099	Lateral Suture System Pack, 45 mm fabella needle, swaged, 80 lb x 80 cm nylon suture, 12 mm crimp, up to 20 kg	2
194100	Lateral Suture System Pack, 62 mm fabella needle, swaged, 100 lb x 80 cm nylon suture, 12 mm crimp, over 20 kg	2



194022

## Lateral Suture Set – Plus

Cranial cruciate ligament rupture is one of the most common reasons for hind limb lameness in dogs. Extra-capsular suture stabilisation with monofilament nylon is a well-established repair technique for this condition. This surgical stabilisation set provides all the necessary equipment for the veterinary surgeon to perform this procedure. Identical to CrCL Stabilisation Basic, but with 194091 instead (Compound action crimping tool).

Lateral Suture Set – Plus		
Item No.	Description	Quantity
194023	Complete set, consisting of:	
194091	Compound Action Crimping Forceps, L 230 mm	
194098	Lateral Suture System Pack, 30 mm fabella needle, swaged, 50 lb x 50 cm nylon suture, 10 mm crimp, up to 10 kg	2
194099	Lateral Suture System Pack, 45 mm fabella needle, swaged, 80 lb x 80 cm nylon suture, 12 mm crimp, up to 20 kg	2
194100	Lateral Suture System Pack, 62 mm fabella needle, swaged, 100 lb x 80 cm nylon suture, 12 mm crimp, over 20 kg	2



194023

# Cruciate Ligament Surgery

## TTA Classic Set

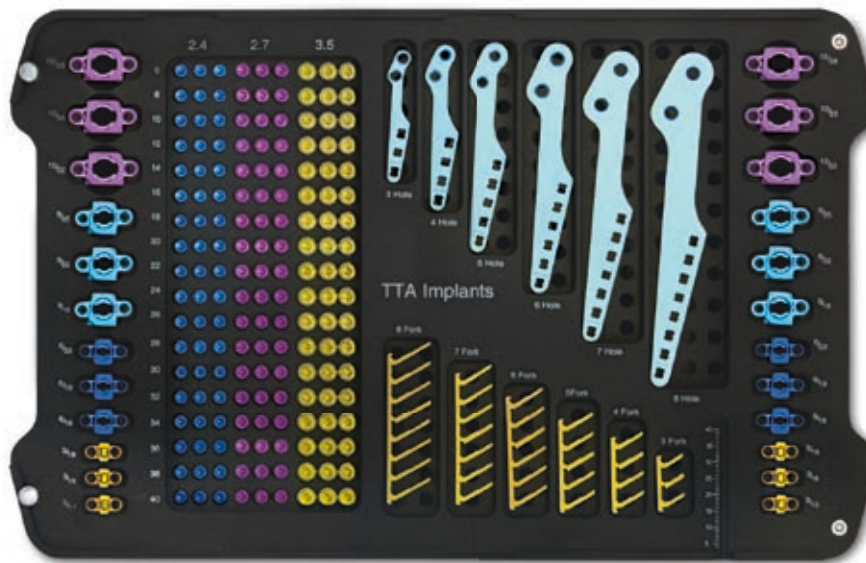

# TTA CLASSIC SET – COMPONENTS

Tibial tuberosity advancement plates +/- forks and cages are designed to counteract cranial tibial thrust in dogs and are available in a range of sizes. In addition to creating joint stability, TTA spacers can be used concurrently to correct medial patella luxation. A wide selection of implant sizes are available to help tailor this procedure.

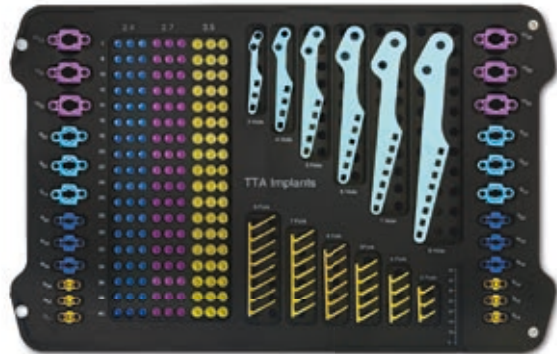

191119



191005



191008



191011



191017

191150



191024



19103801



191054



191067



## TTA CLASSIC SET – ITEM LIST

TTA Classic Set		
Item No.	Description	Quantity
191150	TTA Classic Set, consisting of:	
191099	Instrument Tray	2
191076	Plate Bender	1
191073	Drill Guide, for 8-hole forks	1
191074	Drill Guide for 4-hole forks	1
191117	Pin, Ø 1.7 mm	1
191083	Pin, Ø 1.9 mm	1
191075	Fork Inserter	1
191077	T-Handle	1
191079	Spreader, 6 mm	1
191080	Spreader, 9 mm	1
191081	Spreader, 12 mm	1
191084	Drill Sleeve, Ø 2.7/2.0	1
191085	Drill Sleeve, Ø 3.5/2.5	1
191091	Drill Bit, Ø 1.8 mm, round shank	1
191116	Drill Bit, Ø 2.0 mm, round shank	1
191092	Drill Bit, Ø 2.5 mm, round shank	1
191115	Depth Gauge, 6 – 40 mm	1
191087	Bone Plate Holding Forceps, angled, 160 mm	1
191096	Screwdriver Handle, AO Quick Coupling	1
191114	Screwdriver Insert, Hex, Ø 2.4/2.7/3.5	1
191112	Holding Sleeve, for screws Ø 2.4/2.7/3.5	1
191001	Cage 3/13, gold, titanium	2
191002	Cage 3/16, gold, titanium	2
191119	Cage 3/19, gold, titanium	2
191003	Cage 6/16, blue, titanium	2
191004	Cage 6/19, blue, titanium	2
191005	Cage 6/22, blue, titanium	2
191006	Cage 9/19, light blue, titanium	2
191007	Cage 9/22, light blue, titanium	2
191008	Cage 9/25, light blue, titanium	2
191009	Cage 12/22, magenta, titanium	2
191010	Cage 12/25, magenta, titanium	2
191011	Cage 12/28, magenta, titanium	2
191015	Fork, 3 prongs, titanium	1
191016	Fork, 4 prongs, titanium	1
191017	Fork, 5 prongs, titanium	1
191018	Fork, 6 prongs, titanium	1
191019	Fork, 7 prongs, titanium	1
191020	Fork, 8 prongs, titanium	1
191022	Plate, 3 holes, titanium	1
191023	Plate, 4 holes, titanium	1
191024	Plate, 5 holes, titanium	1
191025	Plate, 6 holes, titanium	1
191026	Plate, 7 holes, titanium	1
191027	Plate, 8 holes, titanium	1
191126	Cortical Screw, Ø 2.4 x L 6 mm, blue, titanium	3
191127	Cortical Screw, Ø 2.4 x L 8 mm, blue, titanium	3
19102801	Cortical Screw, Ø 2.4 x L 10 mm, blue, titanium	3
19102901	Cortical Screw, Ø 2.4 x L 12 mm, blue, titanium	3

TTA Classic Set		
Item No.	Description	Quantity
19103001	Cortical Screw, Ø 2.4 x L 14 mm, blue, titanium	3
19103101	Cortical Screw, Ø 2.4 x L 16 mm, blue, titanium	3
19103201	Cortical Screw, Ø 2.4 x L 18 mm, blue, titanium	3
19103301	Cortical Screw, Ø 2.4 x L 20 mm, blue, titanium	3
19103401	Cortical Screw, Ø 2.4 x L 22 mm, blue, titanium	3
19103501	Cortical Screw, Ø 2.4 x L 24 mm, blue, titanium	3
19103601	Cortical Screw, Ø 2.4 x L 26 mm, blue, titanium	3
19103701	Cortical Screw, Ø 2.4 x L 28 mm, blue, titanium	3
19103801	Cortical Screw, Ø 2.4 x L 30 mm, blue, titanium	3
19103901	Cortical Screw, Ø 2.4 x L 32 mm, blue, titanium	3
19104001	Cortical Screw, Ø 2.4 x L 34 mm, blue, titanium	3
19104101	Cortical Screw, Ø 2.4 x L 36 mm, blue, titanium	3
19104201	Cortical Screw, Ø 2.4 x L 38 mm, blue, titanium	3
19104301	Cortical Screw, Ø 2.4 x L 40 mm, blue, titanium	3
19112801	Cortical Screw, Ø 2.7 x L 6 mm, magenta, titanium	3
191128	Cortical Screw, Ø 2.7 x L 8 mm, magenta, titanium	3
191044	Cortical Screw, Ø 2.7 x L 10 mm, magenta, titanium	3
191045	Cortical Screw, Ø 2.7 x L 12 mm, magenta, titanium	3
191046	Cortical Screw, Ø 2.7 x L 14 mm, magenta, titanium	3
191047	Cortical Screw, Ø 2.7 x L 16 mm, magenta, titanium	3
191048	Cortical Screw, Ø 2.7 x L 18 mm, magenta, titanium	3
191049	Cortical Screw, Ø 2.7 x L 20 mm, magenta, titanium	3
191050	Cortical Screw, Ø 2.7 x L 22 mm, magenta, titanium	3
191051	Cortical Screw, Ø 2.7 x L 24 mm, magenta, titanium	3
191052	Cortical Screw, Ø 2.7 x L 26 mm, magenta, titanium	3
191053	Cortical Screw, Ø 2.7 x L 28 mm, magenta, titanium	3
191054	Cortical Screw, Ø 2.7 x L 30 mm, magenta, titanium	3
191055	Cortical Screw, Ø 2.7 x L 32 mm, magenta, titanium	3
191056	Cortical Screw, Ø 2.7 x L 34 mm, magenta, titanium	3
191129	Cortical Screw, Ø 2.7 x L 36 mm, magenta, titanium	3
191130	Cortical Screw, Ø 2.7 x L 38 mm, magenta, titanium	3
191131	Cortical Screw, Ø 2.7 x L 40 mm, magenta, titanium	3
191063	Cortical Screw, Ø 3.5 x L 6 mm, gold, titanium	3
19105701	Cortical Screw, Ø 3.5 x L 8 mm, gold, titanium	3
191057	Cortical Screw, Ø 3.5 x L 10 mm, gold, titanium	3
191058	Cortical Screw, Ø 3.5 x L 12 mm, gold, titanium	3
191059	Cortical Screw, Ø 3.5 x L 14 mm, gold, titanium	3
191060	Cortical Screw, Ø 3.5 x L 16 mm, gold, titanium	3
191061	Cortical Screw, Ø 3.5 x L 18 mm, gold, titanium	3
191062	Cortical Screw, Ø 3.5 x L 20 mm, gold, titanium	3
191063	Cortical Screw, Ø 3.5 x L 22 mm, gold, titanium	3
191064	Cortical Screw, Ø 3.5 x L 24 mm, gold, titanium	3
191065	Cortical Screw, Ø 3.5 x L 26 mm, gold, titanium	3
191066	Cortical Screw, Ø 3.5 x L 28 mm, gold, titanium	3
191067	Cortical Screw, Ø 3.5 x L 30 mm, gold, titanium	3
191068	Cortical Screw, Ø 3.5 x L 32 mm, gold, titanium	3
191069	Cortical Screw, Ø 3.5 x L 34 mm, gold, titanium	3
191070	Cortical Screw, Ø 3.5 x L 36 mm, gold, titanium	3
191071	Cortical Screw, Ø 3.5 x L 38 mm, gold, titanium	3
191072	Cortical Screw, Ø 3.5 x L 40 mm, gold, titanium	3

# INFUSION

## InfusoVet Connect

*Smart veterinary infusion pump, that is easy to use, compact and portable*

Integrated  
WLAN

Touch screen  
operation



GO **ONLINE** NOW TO FIND OUT MORE

[www.eickemeyer.com/practice-furniture/infusion-syringepumps](http://www.eickemeyer.com/practice-furniture/infusion-syringepumps)

# Cruciate Ligament Surgery

TPLO



# EICKLOXX TPLO OSTEOSYNTHESIS SYSTEM – COMPONENTS

The EickLoxx TPLO is a newly developed, angle-stable, osteosynthesis system, recommended for dogs and cats weighing up to c. 60 kg.

As with the EickLoxx Small and Large osteosynthesis systems, the EickLoxx TPLO differentiates itself with the polyaxial placement of custom-fit screws, combining the advantages of being an angle-stable system with the ability to place screws at an angle of up to  $\pm 15^\circ$  in the distal plate area. A unidirectional jig funnel is placed in a pre-angled direction to guide the screws at the head of the plate.

The biocompatible titanium plates are available in seven sizes, for both the right and left stifle. The anatomically contoured plates can also be bent, in two different planes, to ensure a perfect fit and good perfusion of the bone.

The plate sizes XS and S can be used with either  $\varnothing 1.7$  mm or  $\varnothing 2.3$  mm screws. The larger plates can also be combined with  $\varnothing 2.7$  mm and  $\varnothing 3.5$  mm screws. The plate sizes XS and S as well as the  $\varnothing 1.7$  mm,  $\varnothing 2.3$  mm and  $\varnothing 4.0$  mm screws are not included in the TPLO Kit and can be added if necessary.

The system consists of two perforated instrument trays that fit inside a single container:

- ▶ TPLO Perforated Tray 1 contains the instruments
- ▶ TPLO Perforated Tray 2 contains:
  - Plate sizes M – XXXL (left and right)
  - Implant module for screws  $\varnothing 1.7, 2.3, 2.7, 3.5$  and  $4.0$  mm

## Titanium EickLoxx TPLO Plates

- ▶ Bendable
- ▶ Multidirectional locking
- ▶ System: 2.7 / 3.5
- ▶ 5 locking plates, for both left and right, 3/3 and 4/4 holes, 46 – 85 mm

**187762 – 187766 / 187772 – 187776**

## Titanium Locking Screws

- ▶ Self-drilling, self-tapping
- ▶ 40 Titanium Locking Screws  $\varnothing 2.7$  mm, light blue, length: 10 – 40 mm
- ▶ 40 Titanium Locking Screws  $\varnothing 3.5$  mm, magenta, length: 10 – 40 mm

The geometry of the screw heads and screw holes allow for multidirectional placement  $\pm 15^\circ$  longitudinally and transversally, with the aid of a drill guide funnel.

**185535 – 185545 / 185570 – 185585 / 185600 – 185604**

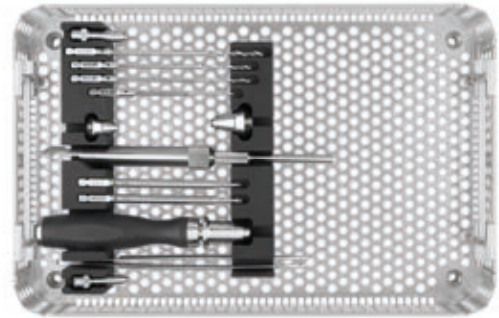

187735



187763

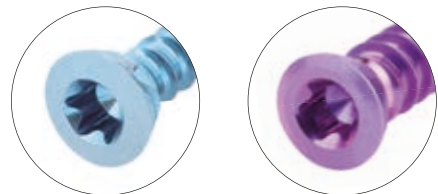

185538



185573



## EICKLOXX TPLO OSTEOSYNTHESIS SYSTEM – CHARACTERISTICS

---

- ▶ The EickLoxx TPLO bone plates minimize contact with the periosteum and therefore, unlike conventional compression plates, reduce the iatrogenic load on the bone, allowing good perfusion and healing.
- ▶ Maintaining perfusion significantly reduces the risk of infection and accelerates bone healing
- ▶ The biocompatibility of the titanium increases the resistance to infection and reduces the risk of fretting

### Biological benefits

- ▶ Reduces damage to the vascular supply
- ▶ Increased resistance to infection
- ▶ Accelerated healing



# EICKLOXX TPLO OSTEOSYNTHESIS SYSTEM – ITEM LIST

EickLoxx TPLO Osteosynthesis System		
Item No.	Description	Quantity
187735	Complete set, consisting of:	
185564	EickLoxx TPLO Sieve Tray 1, without instruments	1
185565	EickLoxx TPLO Sieve Tray 2, without implants	1
187035	EickLoxx Screw Implant Module, without screws	1
185507	Twist Drill, Ø 1.4 mm, AO Quick Coupling	1
185508	Twist Drill, Ø 1.8 mm, AO Quick Coupling	1
185509	Twist Drill, Ø 2.0 mm, AO Quick Coupling	1
197735	Twist Drill, Ø 2.5 mm, AO Quick Coupling	1
185510	Screwdriver Blade, Torx 6, AO Quick Coupling	1
185511	Screwdriver Blade, Torx 10, AO Quick Coupling	1
185512	Drill Guide Funnel, multi-directional, 1.7/2.3	1
185513	Drill Guide Funnel, multi-directional, 2.7/3.5/4.0	1
185779	Plate and Screw Holding Forceps, stainless steel, angled, L 150 mm	1
185515	Silicone Screwdriver Handle, cannulated, AO Quick Coupling, L 120 mm	1
187737	Depth Gauge, measuring range 50 mm, probe 1.3 mm	1
185562	Jig Funnel, unidirectional 1.7 / 2.3	1
185563	Jig Funnel, unidirectional, 2.7 / 3.5 / 4.0	1
185516	Plate Positioning Pin, Ø 1.4 x L 63 mm	4
185535	Titanium Locking Screw, Ø 2.7 x L 10 mm, multi-directional, light blue, Torx 10, self-drilling, self-tapping	3
185536	Titanium Locking Screw, Ø 2.7 x L 12 mm, multi-directional, light blue, Torx 10, self-drilling, self-tapping	3
185537	Titanium Locking Screw, Ø 2.7 x L 14 mm, multi-directional, light blue, Torx 10, self-drilling, self-tapping	3
185538	Titanium Locking Screw, Ø 2.7 x L 16 mm, multi-directional, light blue, Torx 10, self-drilling, self-tapping	3
185539	Titanium Locking Screw, Ø 2.7 x L 18 mm, multi-directional, light blue, Torx 10, self-drilling, self-tapping	3
185540	Titanium Locking Screw, Ø 2.7 x L 20 mm, multi-directional, light blue, Torx 10, self-drilling, self-tapping	3
185541	Titanium Locking Screw, Ø 2.7 x L 22 mm, multi-directional, light blue, Torx 10, self-drilling, self-tapping	3
185542	Titanium Locking Screw, Ø 2.7 x L 24 mm, multi-directional, light blue, Torx 10, self-drilling, self-tapping	3
185543	Titanium Locking Screw, Ø 2.7 x L 26 mm, multi-directional, light blue, Torx 10, self-drilling, self-tapping	3
185544	Titanium Locking Screw, Ø 2.7 x L 28 mm, multi-directional, light blue, Torx 10, self-drilling, self-tapping	3
185545	Titanium Locking Screw, Ø 2.7 x L 30 mm, multi-directional, light blue, Torx 10, self-drilling, self-tapping	3
185600	Titanium Locking Screw, Ø 2.7 x L 32 mm, multi-directional, light blue, Torx 10, self-drilling, self-tapping	3
185601	Titanium Locking Screw, Ø 2.7 x L 34 mm, multi-directional, light blue, Torx 10, self-drilling, self-tapping	1
185602	Titanium Locking Screw, Ø 2.7 x L 36 mm, multi-directional, light blue, Torx 10, self-drilling, self-tapping	1
185603	Titanium Locking Screw, Ø 2.7 x L 38 mm, multi-directional, light blue, Torx 10, self-drilling, self-tapping	1
185604	Titanium Locking Screw, Ø 2.7 x L 40 mm, multi-directional, light blue, Torx 10, self-drilling, self-tapping	1
185570	Titanium Locking Screw, Ø 3.5 x L 10 mm, multi-directional, magenta, Torx 10, self-drilling, self-tapping	3
185571	Titanium Locking Screw, Ø 3.5 x L 12 mm, multi-directional, magenta, Torx 10, self-drilling, self-tapping	3
185572	Titanium Locking Screw, Ø 3.5 x L 14 mm, multi-directional, magenta, Torx 10, self-drilling, self-tapping	3
185573	Titanium Locking Screw, Ø 3.5 x L 16 mm, multi-directional, magenta, Torx 10, self-drilling, self-tapping	3
185574	Titanium Locking Screw, Ø 3.5 x L 18 mm, multi-directional, magenta, Torx 10, self-drilling, self-tapping	3
185575	Titanium Locking Screw, Ø 3.5 x L 20 mm, multi-directional, magenta, Torx 10, self-drilling, self-tapping	3
185576	Titanium Locking Screw, Ø 3.5 x L 22 mm, multi-directional, magenta, Torx 10, self-drilling, self-tapping	3
185577	Titanium Locking Screw, Ø 3.5 x L 24 mm, multi-directional, magenta, Torx 10, self-drilling, self-tapping	3
185578	Titanium Locking Screw, Ø 3.5 x L 26 mm, multi-directional, magenta, Torx 10, self-drilling, self-tapping	3
185579	Titanium Locking Screw, Ø 3.5 x L 28 mm, multi-directional, magenta, Torx 10, self-drilling, self-tapping	3
185580	Titanium Locking Screw, Ø 3.5 x L 30 mm, multi-directional, magenta, Torx 10, self-drilling, self-tapping	3
185581	Titanium Locking Screw, Ø 3.5 x L 32 mm, multi-directional, magenta, Torx 10, self-drilling, self-tapping	3
185582	Titanium Locking Screw, Ø 3.5 x L 34 mm, multi-directional, magenta, Torx 10, self-drilling, self-tapping	1
185583	Titanium Locking Screw, Ø 3.5 x L 36 mm, multi-directional, magenta, Torx 10, self-drilling, self-tapping	1
185584	Titanium Locking Screw, Ø 3.5 x L 38 mm, multi-directional, magenta, Torx 10, self-drilling, self-tapping	1
185585	Titanium Locking Screw, Ø 3.5 x L 40 mm, multi-directional, magenta, Torx 10, self-drilling, self-tapping	1

# EICKLOXX TPLO OSTEOSYNTHESIS SYSTEM – ITEM LIST

EickLoxx TPLO Osteosynthesis System		
Item No.	Description	Quantity
187762	TPLO Locking Plate, 3/3 holes, M, right, System 2.7 / 3.5, titanium, magenta, L 46 mm	1
187772	TPLO Locking Plate, 3/3 holes, M, left, System 2.7 / 3.5, titanium, magenta, L 46 mm	1
187763	TPLO Locking Plate, 3/3 holes, L, right, System 2.7 / 3.5, titanium, magenta, L 54 mm	1
187773	TPLO Locking Plate, 3/3 holes, L, left, System 2.7 / 3.5, titanium, magenta, L 54 mm	1
187764	TPLO Locking Plate, 3/3 holes, XL, right, System 2.7 / 3.5, titanium, magenta, L 64 mm	1
187774	TPLO Locking Plate, 3/3 holes, XL, left, System 2.7 / 3.5, titanium, magenta, L 64 mm	1
187765	TPLO Locking Plate, 4/4 holes, XXL, right, System 2.7 / 3.5, titanium, magenta, L 74 mm	1
187775	TPLO Locking Plate, 4/4 holes, XXL, left, System 2.7 / 3.5, titanium, magenta, L 74 mm	1
187766	TPLO Locking Plate, 4/4 holes, XXXL, right, System 2.7 / 3.5, titanium, magenta, L 85 mm	1
187776	TPLO Locking Plate, 4/4 holes, XXXL, left, System 2.7 / 3.5, titanium, magenta, L 85 mm	1
185555	Container, non-perforated bottom, perforated lid, silver, dimensions (in mm): L 312 x W 183 x H 122 mm	1

Optional Accessories		
Item No.	Description	Quantity
185521	Titanium Locking Screw Ø 1.7 x L 8 mm, multi-directional, silver, Torx 6, self-drilling, self-tapping	1
185522	Titanium Locking Screw Ø 1.7 x L 10 mm, multi-directional, silver, Torx 6, self-drilling, self-tapping	1
185523	Titanium Locking Screw, Ø 1.7 x L 12 mm, multi-directional, silver, Torx 6, self-drilling, self-tapping	1
185524	Titanium Locking Screw, Ø 1.7 x L 14 mm, multi-directional, silver, Torx 6, self-drilling, self-tapping	1
185525	Titanium Locking Screw, Ø 1.7 x L 16 mm, multi-directional, silver, Torx 6, self-drilling, self-tapping	1
185526	Titanium Locking Screw, Ø 1.7 x L 18 mm, multi-directional, silver, Torx 6, self-drilling, self-tapping	1
185527	Titanium Locking Screw, Ø 1.7 x L 20 mm, multi-directional, silver, Torx 6, self-drilling, self-tapping	1
185528	Titanium Locking Screw, Ø 2.3 x L 8 mm, multi-directional, gold, Torx 6, self-drilling, self-tapping	1
185529	Titanium Locking Screw, Ø 2.3 x L 10 mm, multi-directional, gold, Torx 6, self-drilling, self-tapping	1
185530	Titanium Locking Screw, Ø 2.3 x L 12 mm, multi-directional, gold, Torx 6, self-drilling, self-tapping	1
185531	Titanium Locking Screw, Ø 2.3 x L 14 mm, multi-directional, gold, Torx 6, self-drilling, self-tapping	1
185532	Titanium Locking Screw, Ø 2.3 x L 16 mm, multi-directional, gold, Torx 6, self-drilling, self-tapping	1
185533	Titanium Locking Screw, Ø 2.3 x L 18 mm, multi-directional, gold, Torx 6, self-drilling, self-tapping	1
185534	Titanium Locking Screw, Ø 2.3 x L 20 mm, multi-directional, gold, Torx 6, self-drilling, self-tapping	1
185590	Titanium Locking Screw, Ø 4.0 x L 10 mm, multi-directional, blue, Torx 10, self-drilling, self-tapping	1
185591	Titanium Locking Screw, Ø 4.0 x L 12 mm, multi-directional, blue, Torx 10, self-drilling, self-tapping	1
185592	Titanium Locking Screw, Ø 4.0 x L 14 mm, multi-directional, blue, Torx 10, self-drilling, self-tapping	1
185593	Titanium Locking Screw, Ø 4.0 x L 16 mm, multi-directional, blue, Torx 10, self-drilling, self-tapping	1
185594	Titanium Locking Screw, Ø 4.0 x L 18 mm, multi-directional, blue, Torx 10, self-drilling, self-tapping	1
185595	Titanium Locking Screw, Ø 4.0 x L 20 mm, multi-directional, blue, Torx 10, self-drilling, self-tapping	1
185596	Titanium Locking Screw, Ø 4.0 x L 22 mm, multi-directional, blue, Torx 10, self-drilling, self-tapping	1
185597	Titanium Locking Screw, Ø 4.0 x L 24 mm, multi-directional, blue, Torx 10, self-drilling, self-tapping	1
185460	Titanium Locking Screw, Ø 4.0 x L 26 mm, multi-directional, blue, Torx 10, self-drilling, self-tapping	1
185461	Titanium Locking Screw, Ø 4.0 x L 28 mm, multi-directional, blue, Torx 10, self-drilling, self-tapping	1
185462	Titanium Locking Screw, Ø 4.0 x L 30 mm, multi-directional, blue, Torx 10, self-drilling, self-tapping	1
185463	Titanium Locking Screw, Ø 4.0 x L 32 mm, multi-directional, blue, Torx 10, self-drilling, self-tapping	1
185464	Titanium Locking Screw, Ø 4.0 x L 34 mm, multi-directional, blue, Torx 10, self-drilling, self-tapping	1
185465	Titanium Locking Screw, Ø 4.0 x L 36 mm, multi-directional, blue, Torx 10, self-drilling, self-tapping	1
185466	Titanium Locking Screw, Ø 4.0 x L 38 mm, multi-directional, blue, Torx 10, self-drilling, self-tapping	1
185467	Titanium Locking Screw, Ø 4.0 x L 40 mm, multi-directional, blue, Torx 10, self-drilling, self-tapping	1
187760	TPLO Locking Plate, 3/3 holes, XS, right, System 1.7 / 2.3, titanium, magenta, L 30 mm	1
187770	TPLO Locking Plate, 3/3 holes, XS, left, System 1.7 / 2.3, titanium, magenta, L 30 mm	1
187761	TPLO Locking Plate, 3/3 holes, S, right, System 1.7 / 2.3, titanium, magenta, L 39 mm	1
187771	TPLO Locking Plate, 3/3 holes, S, left, System 1.7 / 2.3, titanium, magenta, L 39 mm	1

# TPLO SAW JIG AND CANNULATED SAW BLADE SET – COMPONENTS AND CHARACTERISTICS

## TPLO Saw Jigs

The TPLO saw jig is inserted with the use of a guide pin. This acts as an axis for the saw blade, guaranteeing a reproducible circular section, close to the centre of the joint, and the insertion of the medial collateral ligament. In this way, undesired valgus and varus positions of the tibia are avoided. There are two saw jigs for saw blades R 9–R 18 mm and R 21–R 33 mm, allowing a precise cut for both very small and very large patients.

**192861, 192862**

## Cannulated TPLO Saw Blades

The longitudinally cannulated TPLO saw blades enable precise axial guidance via a guide pin; for optimal use, they are supplied with our specially designed saw jig set.

The TPLO saw blades have specially shaped recesses in the cutting blade. The triangular shaft on the saw blades makes them compatible with various drill systems.

The saw blades with a blade thickness of 0.6 mm are available in radii 9, 12, 15, 18, 21, 24, 27, 30 and 33 mm.

## Advantages

- ▶ Minimal heat transfer due to recesses in the cutting surface
- ▶ Reduced vibration
- ▶ Good visibility through hole perforations
- ▶ Standard triangular shaft connection

**192851 – 192859**

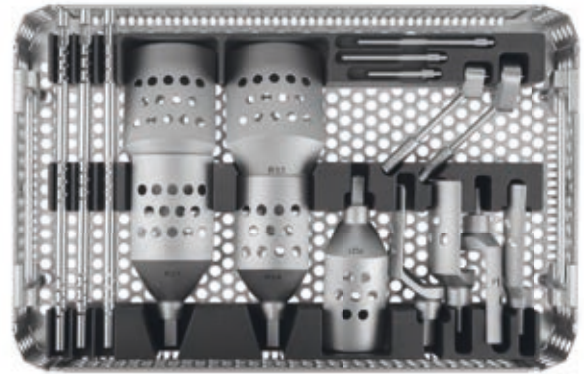

192860

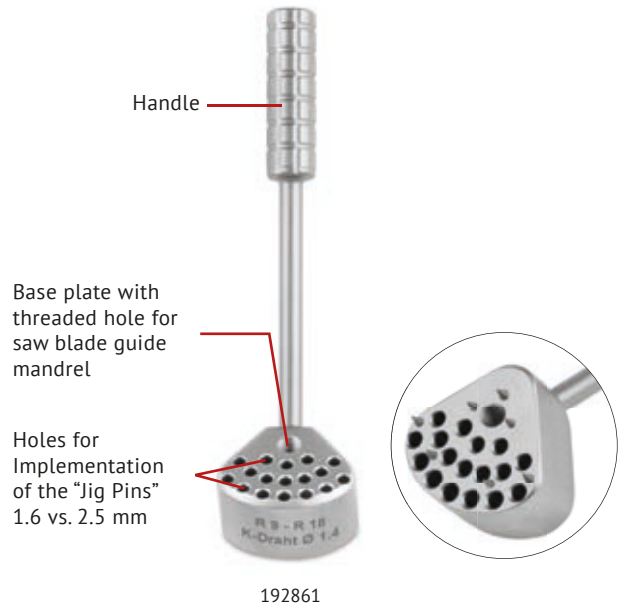

192861

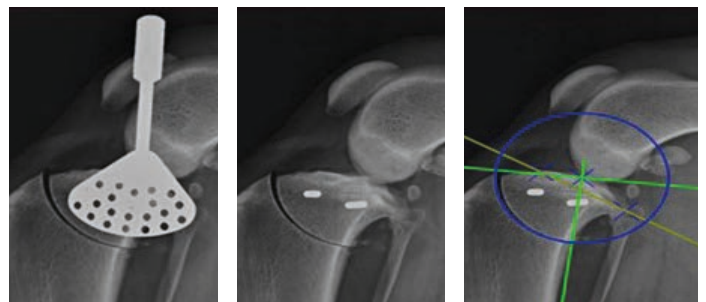

## TPLO SAW JIG AND CANNULATED SAW BLADE SET – ITEM LIST

TPLO Saw Jig and Cannulated Saw Blade Set		
Item No.	Description	Quantity
192860	Complete set, consisting of:	
192866	Mesh Tray for TPLO Saw Jigs and cannulated Saw Blades, without instruments	1
192861	TPLO Saw Jig, R 9 – R 18 mm	1
192862	TPLO Saw Jig, R 21 – R 33 mm	1
192863	TPLO Guide Mandrel, short, 25 mm	1
192864	TPLO Guide Mandrel, medium, 40 mm	1
192865	TPLO Guide Mandrel, long, 55 mm	1
185109	KIRSCHNER Wire, Ø 1.1 x L 150 mm, trocar/blunt, round shaft	5
185114	KIRSCHNER Wire, Ø 1.4 x L 150 mm, trocar/blunt, round shaft	5
185116	KIRSCHNER Wire, Ø 2.0 x L 150 mm, trocar/blunt, round shaft	5
185118	Cylinder, for KIRSCHNER wires up to 150 mm length	3
192851	TPLO Saw Blade, cannulated, triangular shaft, R 9 x L 45 mm	1
192852	TPLO Saw Blade, cannulated, triangular shaft, R 12 x L 45 mm	1
192853	TPLO Saw Blade, cannulated, triangular shaft, R 15 x L 45 mm	1
192854	TPLO Saw Blade, cannulated, triangular shaft, R 18 x L 45 mm	1
192855	TPLO Saw Blade, cannulated, triangular shaft, R 21 x L 45 mm	1
192856	TPLO Saw Blade, cannulated, triangular shaft, R 24 x L 45 mm	1
192857	TPLO Saw Blade, cannulated, triangular shaft, R 27 x L 50 mm	1
192858	TPLO Saw Blade, cannulated, triangular shaft, R 30 x L 50 mm	1
192859	TPLO Saw Blade, cannulated, triangular shaft, R 33 x L 50 mm	1

Optional Accessories		
Item No.	Description	Quantity
185554	Container, unperforated tub, including perforated lid, dimensions (in mm): L 312 x W 183 x H 65	1

## Case Report

Dr. Klaus Zahn, Ismaning, Germany, September 2018

### 1. Access



Fig. 1: Craniomedial skin incision from the level of the patella to the proximal third of the tibia

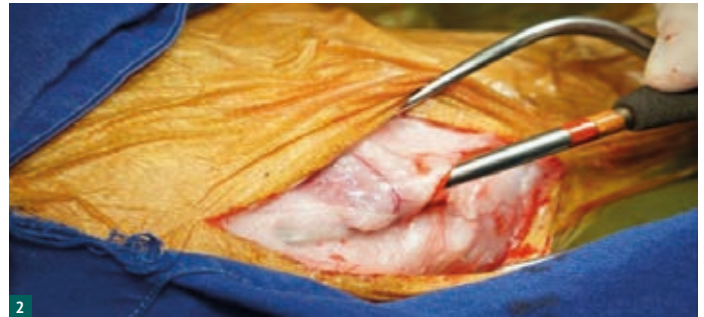

Fig. 2: Subperiosteal mobilisation of the muscles (M. sartorius, gracilis, semitendinosus)



Fig. 3: Incision at the base of the muscles (M. sartorius, gracilis, semitendinosus)

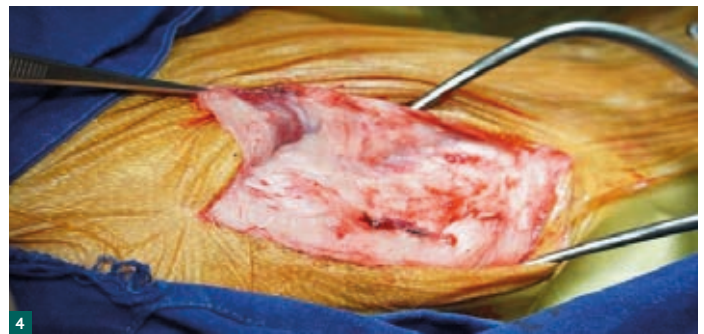

Fig. 4: The muscle flap is retracted caudally and the medial view of the tibial head is visible

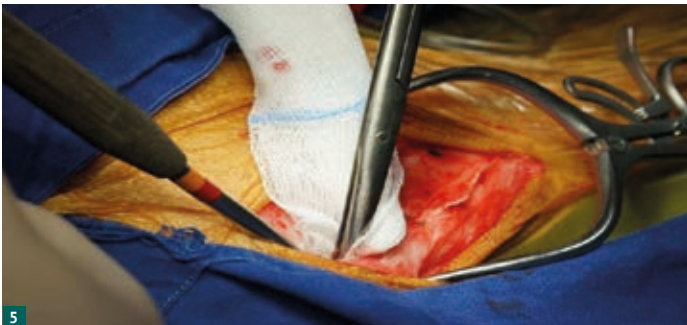
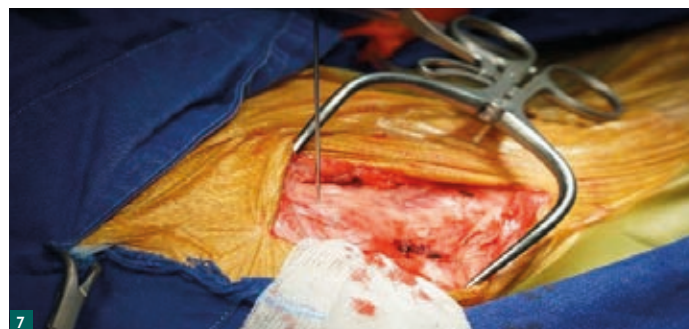

Fig. 5: Caudal to the patellar ligament, the knee fascia is incised in a parallel manner; a swab is placed between the ligament and the bone to protect against the saw.

### 2. Find the joint axis



Fig. 6 and 7: The joint axis is marked with a 1.0 mm KIRSCHNER wire at the level of the collateral ligament.



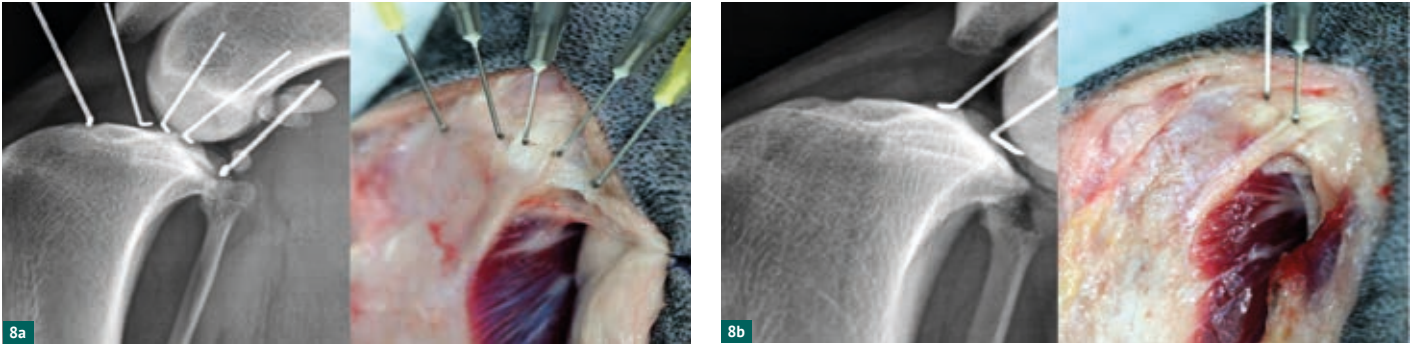

Fig. 8a and 8b: The joint axis lies in front of the collateral ligament, at the height of a palpable projection.

### 3. Attach jig pins

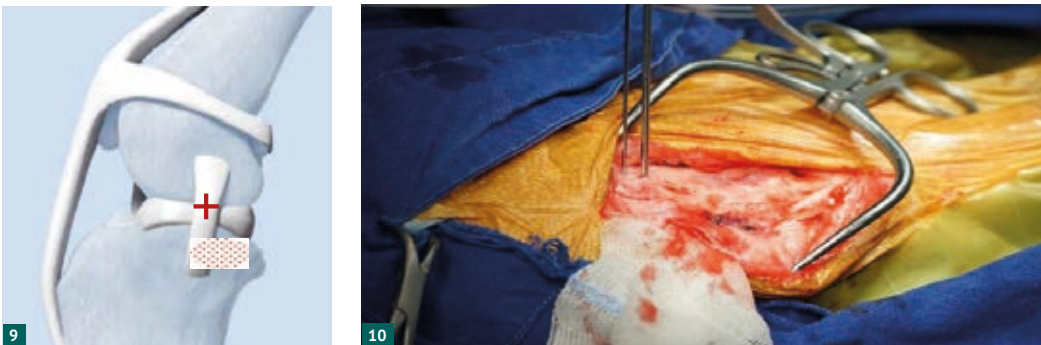

Fig. 9 and 10: A drill wire (1.6 mm or 2.5 mm) is driven approximately 1 cm deep, 2–4 mm distal to the joint plane and parallel to the knee joint axis. A second pin is driven bicortically, in parallel, into the distal tibial shaft. A saw jig can be attached to both pins and the axis alignment can be checked.



Fig. 11: The saw jig with the guide mandrel is first threaded onto the 1 mm KIRSCHNER wire to mark the joint axis. A second KIRSCHNER wire is then threaded into a drill hole in the base plate of the saw jig so that both KIRSCHNER wires run parallel.

### 4. Attach the saw jig



Fig. 12a, 12b and 12c. The KIRSCHNER wire is shortened at the base plate (Fig. 12a). An “auxiliary pin” of the same thickness is inserted into one of the remaining holes in the plate, into the tibial head. This is also shortened and serves to stabilize the saw guide (Fig. 12b). The 1 mm KIRSCHNER wire is removed from the guide mandrel.

### 5. Osteotomy and saw jig

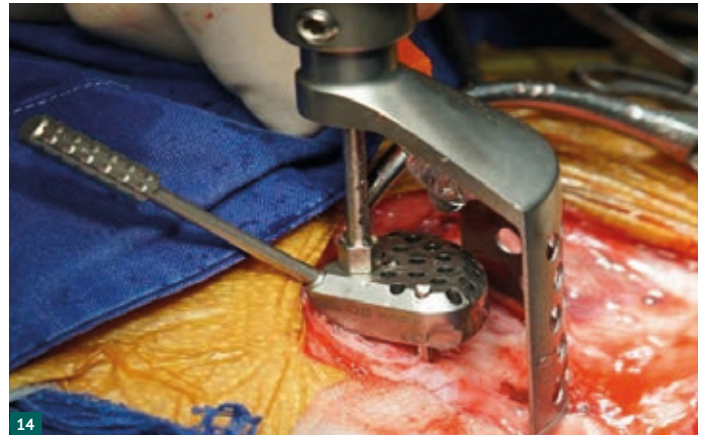
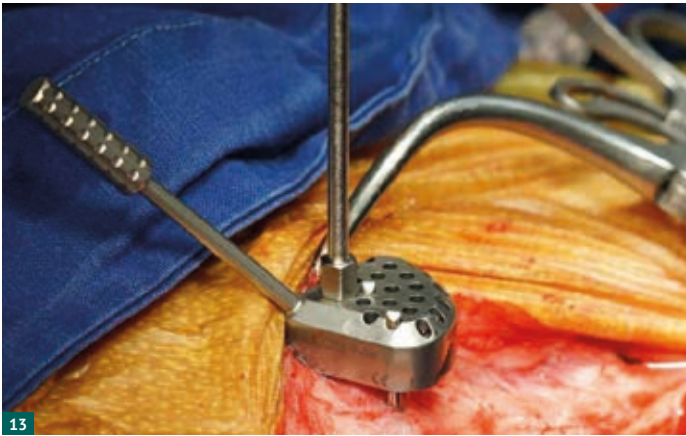

Fig. 13 and 14: The saw guide is used for drilling into the axis. The cannulated saw blade is placed over the guide mandrel. The subsequent “guided oscillation” will provide a cut that should represent the joint plane.

### 6. Mark for rotation

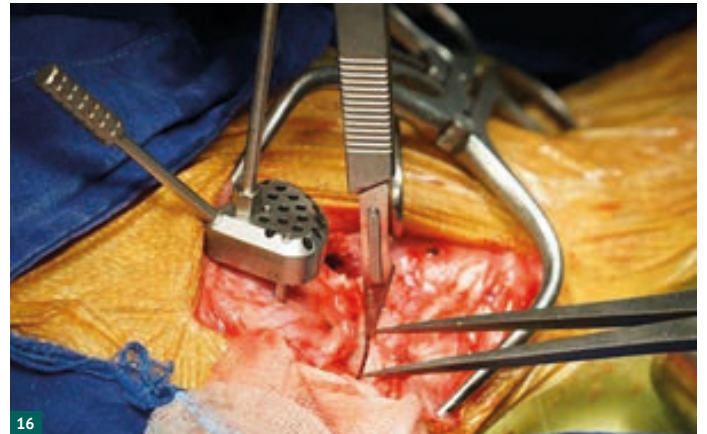

Fig. 15 and 16: The osteotomy is carried out halfway. With a periosteal elevator, the saw cut is freed of any soft tissue.

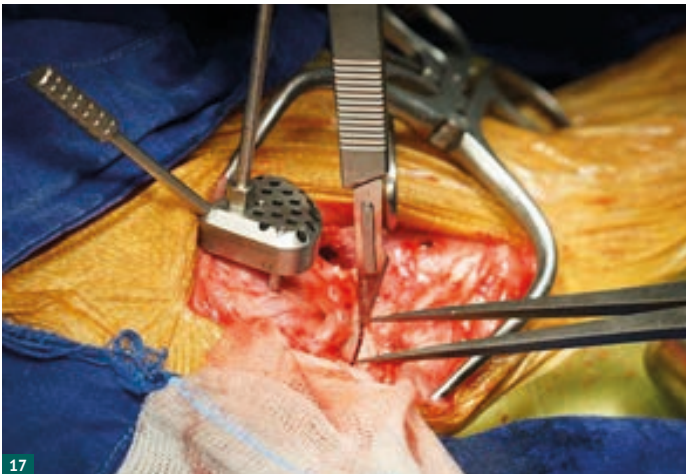

Fig. 17 and 18: With a bone chisel or a scalpel (Fig. 11) a clearly visible notch is made on the proximal segment. With a calliper, the corresponding distance (see table specification) is measured from the notch caudally. A notch is also made on the proximal segment.



## 7. Osteotomy with saw jig



Fig. 19 and 20: The caudal muscles are mobilised subperiosteally in the area of the osteotomy and tamponised with a gauze compress. The long jig pin is replaced by a short one.

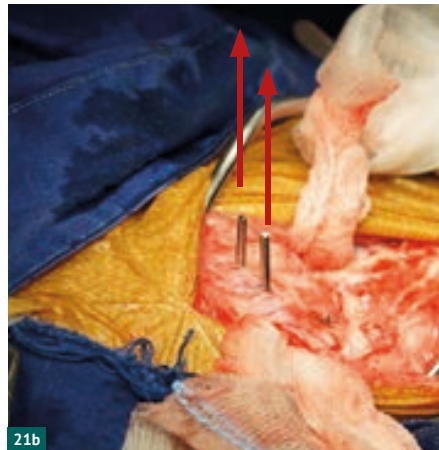

Fig. 21a, 21b and 21c: The osteotomy is completed with continuous rinsing with NaCl and the saw jig removed (centre picture). The auxiliary pin is removed and the shortened jig pin is replaced by a long one.

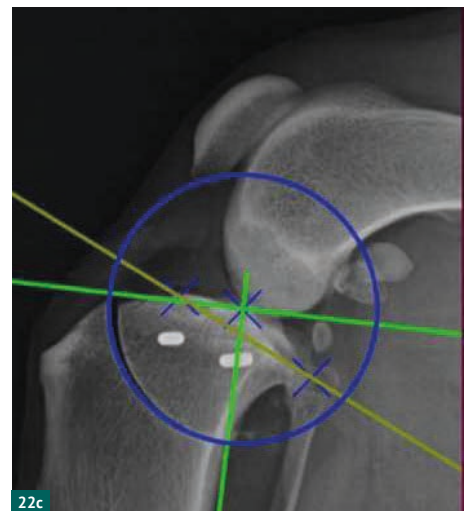
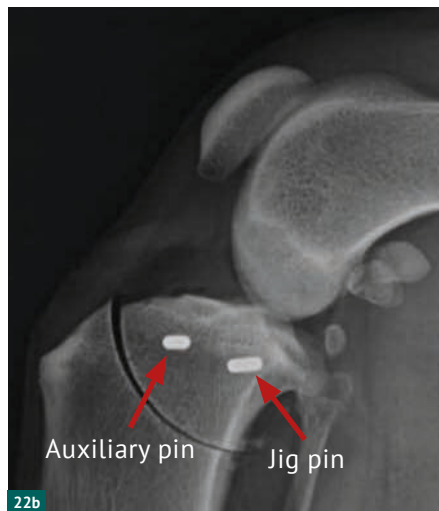

Fig. 22a, 22b and 22c: The saw jig is placed with the guide mandrel over the eminencia intertubercularis and guides the cannulated saw blade over the axis. This guarantees a precise cut.

### 8. Rotation of the tibial head

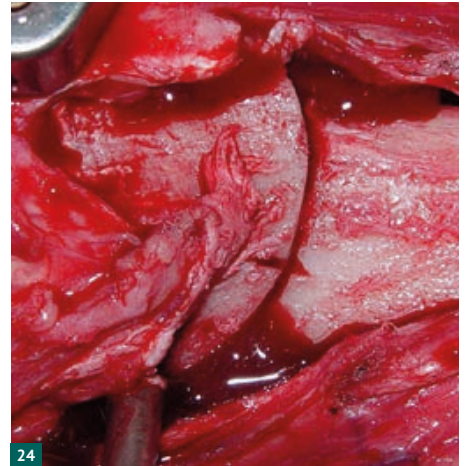
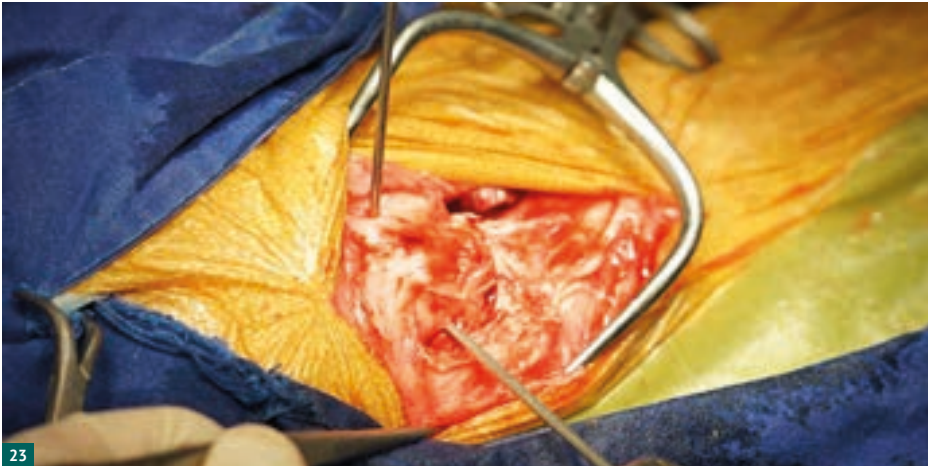

Fig. 23 and 24: A wire, ranging from 1.4 mm (cat) to 4 mm (large dog), is driven from cranial to caudal, at a flat angle into the tibial head. Using this wire as a lever, rotate the tibial head until the angles are congruent.

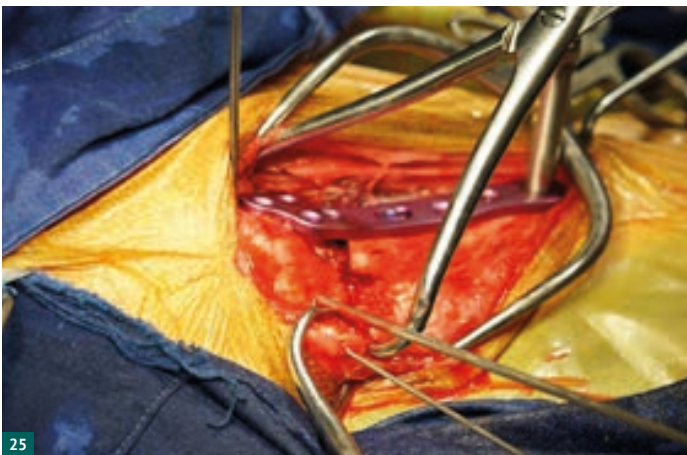

Fig. 25: The rotated tibial head is held with grasping forceps. A drill wire (1.2 mm – 1.4 mm) is then inserted at the lower end of the patellar tendon, through the tibial tuberosity and driven from cranial to caudal into the tibial head.

### 9. Angle stable osteosynthesis with TPLO plate

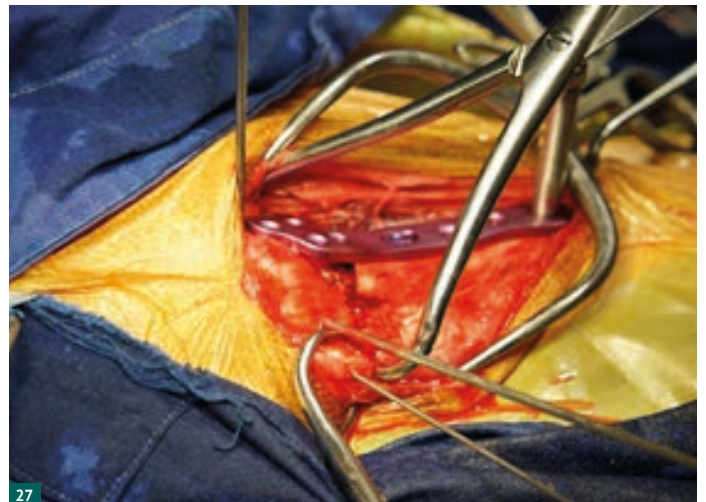
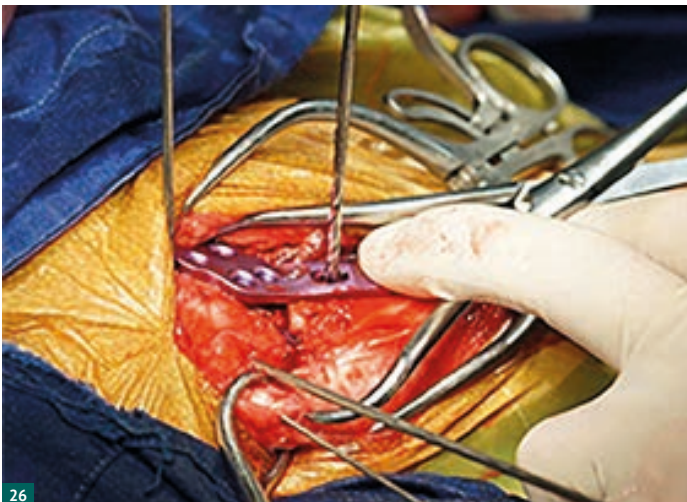

Fig. 26 and 27: The TPLO plate is first attached to the distal segment with the most proximal screw and, finally, with the most distal screw.

## TPLO – CASE REPORT

### 10. 4-row wound closure

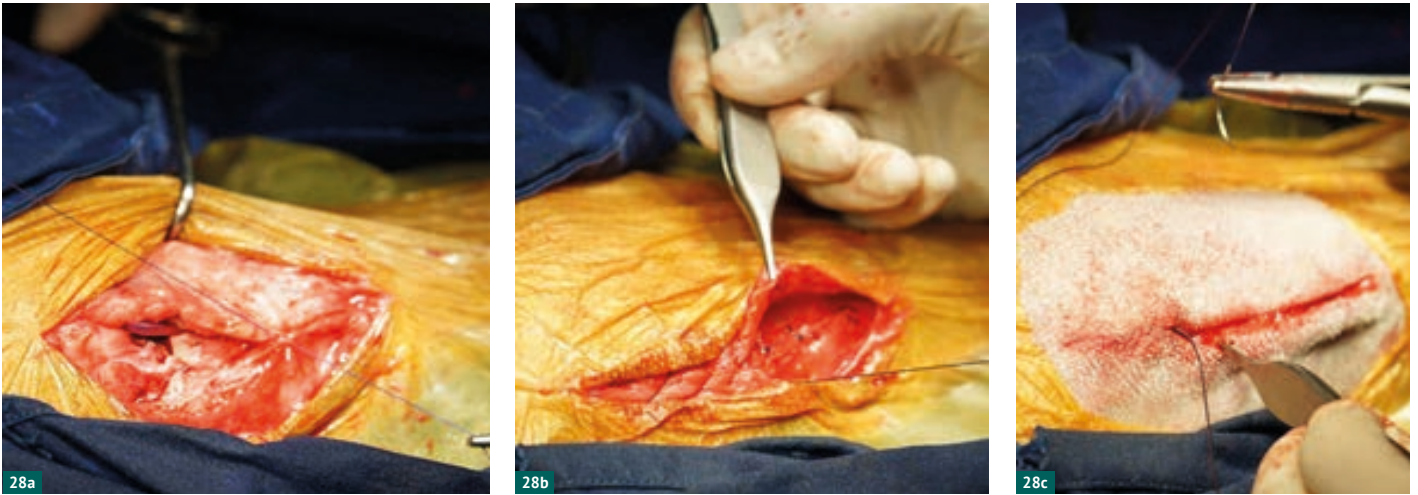

Fig. 28a, 28b and 28c: First, the fascia and muscles are closed with individual staples over the plate. This is followed by a 2-row, continuous subcutaneous suture. Finally, the skin sutures.

## TPLO – ROTATION CHART

	Preoperative Tibial Plateau Angle (TPA)																									
	15°	16°	17°	18°	19°	20°	21°	22°	23°	24°	25°	26°	27°	28°	29°	30°	31°	32°	33°	34°	35°	36°	37°	38°	39°	40°
	Rotation (mm) – determines 5° tibial plateau angle																									
9 mm	1,6	1,7	1,9	2,0	2,2	2,4	2,5	2,7	2,9	3,0	3,2	3,3	3,4	3,6	3,7	3,9	4,1	4,2	4,4	4,5	4,7	4,8	5,0	5,1	5,3	5,4
12 mm	2,0	2,2	2,4	2,6	2,9	3,1	3,3	3,5	3,7	3,9	4,1	4,3	4,5	4,7	4,9	5,1	5,3	5,5	5,7	5,9	6,1	6,3	6,4	6,6	6,8	7,0
15 mm	2,6	2,8	3,1	3,3	3,6	3,8	4,1	4,3	4,6	4,9	5,1	5,4	5,6	5,9	6,1	6,4	6,6	6,9	7,1	7,4	7,6	7,9	8,1	8,4	8,6	8,8
18 mm	3,1	3,4	3,7	4,0	4,3	4,6	4,9	5,2	5,5	5,8	6,1	6,5	6,8	7,1	7,4	7,7	8,0	8,3	8,6	8,9	9,2	9,5	9,8	10,1	10,3	10,6
21 mm	3,6	4,0	4,3	4,7	5,0	5,4	5,8	6,1	6,5	6,8	7,2	7,5	7,9	8,3	8,6	9,0	9,3	9,7	10,0	10,4	10,7	11,1	11,4	11,8	12,1	12,4
24 mm	4,1	4,5	5,0	5,4	5,8	6,2	6,6	7,0	7,4	7,8	8,2	8,6	9,0	9,5	9,9	10,3	10,7	11,1	11,5	11,9	12,3	12,7	13,1	13,5	13,9	14,3
27 mm	4,7	5,1	5,6	6,0	6,5	7,0	7,4	7,9	8,4	8,8	9,3	9,7	10,2	10,6	11,1	11,6	12,0	12,5	12,9	13,4	13,8	14,3	14,7	15,2	15,6	16,1
30 mm	5,2	5,7	6,2	6,7	7,2	7,8	8,3	8,8	9,3	9,8	10,3	10,8	11,3	11,8	12,3	12,9	13,4	13,9	14,4	14,9	15,4	15,9	16,4	16,9	17,4	17,9
33 mm	5,8	6,3	6,9	7,5	8,0	8,6	9,2	9,8	10,3	10,9	11,5	12,0	12,6	13,2	13,7	14,3	14,9	15,4	16,0	16,5	17,1	17,6	18,2	18,8	19,3	19,9

## TPLO NON-CANNULATED SAW BLADES – CHARACTERISTICS

### Precise, low-vibration vision control with minimal bone loss

The TPLO saw blades have specially shaped recesses in the blade, with a slightly wider, stepped cutting edge compared to the rest of the blade. This reduces heat transference to the bone.

The triangular shaft on the saw blades makes them compatible with different systems.

The saw blades, with a thickness of 0.6 mm, are available in radii 12, 15, 18, 21, 24, 27 and 30 mm

### Advantages

- ▶ Minimal heat transfer due to recesses in the cutting surface
- ▶ Reduced vibration
- ▶ Good visibility throughout the cut
- ▶ Standard triangular shaft connection



## TPLO NON-CANNULATED SAW BLADES – ITEM LIST

TPLO Non-cannulated Saw Blades		
Item No.	Description	Quantity
192907	TPLO Saw Blade, non-cannulated, triangular shaft, R 12 x L 45 mm	1
192908	TPLO Saw Blade, non-cannulated, triangular shaft, R 15 x L 45 mm	1
192909	TPLO Saw Blade, non-cannulated, triangular shaft, R 18 x L 45 mm	1
192912	TPLO Saw Blade, non-cannulated, triangular shaft, R 21 x L 45 mm	1
192910	TPLO Saw Blade, non-cannulated, triangular shaft, R 24 x L 45 mm	1
191913	TPLO Saw Blade, non-cannulated, triangular shaft, R 27 x L 50 mm	1
192911	TPLO Saw Blade, non-cannulated, triangular shaft, R 30 x L 50 mm	1

# Cruciate Ligament Surgery

Zlig Intra-Articular Cruciate Ligament Replacement  
Technique (CrCL)

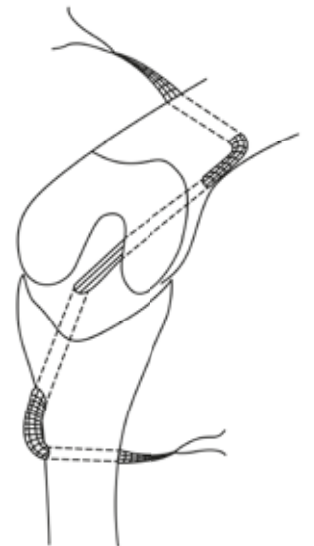

# ZLIG INTRA-ARTICULAR CRUCIATE LIGAMENT REPLACEMENT – COMPONENTS

## The history

The tear of the cranial cruciate ligament is still one of the most common orthopaedic diseases in dogs. The path of the many surgical methods developed for this vary between intracapsular and extracapsular techniques to modern corrective osteotomies that alter the geometry of the affected knee joint. With the development of new materials in medical technology, it is now possible to replace the cranial cruciate ligament in an anatomically correct manner, instead of changing the forces acting on the joint. After a long period of preparatory work by the French Dr Jacques-Phillipe Laboureau, a suitable synthetic ligament is now available for the intra-articular cruciate ligament replacement in small animals. Together with the instrumentation developed by EICKEMEYER®, this new technique for cruciate ligament replacement can now be performed.

## The implant

The Zlig consists of ultra-high-molecular polyethylene with the special feature that the woven structure of the implant is interrupted intra-articularly by “free fibres”. Free parallel fibres reduce fatigue and encourage the ingrowth of fibroblasts and collagen. Each implant is delivered in a sterile packed sleeve, making it easier to handle the implant before it is inserted into the joint. A selection of sizes with different resistances and fibre lengths are available to fit different patient sizes.

### 16 fibres / 10 mm

- ▶ 5–8 kg
- ▶ 2,000 N

**191501**

### 48 fibres / 19 mm

- ▶ 25–45 kg
- ▶ 6,000 N

**191504**

### 24 fibres / 15 mm

- ▶ 8–12 kg
- ▶ 3,000 N

**191502**

### 48 fibres / 22 mm

- ▶ 25–45 kg
- ▶ 6,000 N

**191505**

### 32 fibres / 17 mm

- ▶ 12–25 kg
- ▶ 4,000 N

**191503**

### 48 fibres / 25 mm

- ▶ 25–45 kg
- ▶ 6,000 N

**191506**

## The technology

In this technique, an artificial ligament is used as a total replacement for the cranial cruciate ligament using tunnel-tunnel-technique. The ligament is fixed in the tibia and Os femoris using specially developed cannulated interference screws in drill channels. The screws are guided parallel to the ligament using a guiding wire to avoid deviations. The technology does not cause irreversible damage and the results are reproducible thanks to a quick learning curve. Another great advantage of the technique is the fact that patients can put weight on the hind leg immediately after the operation without any risks.

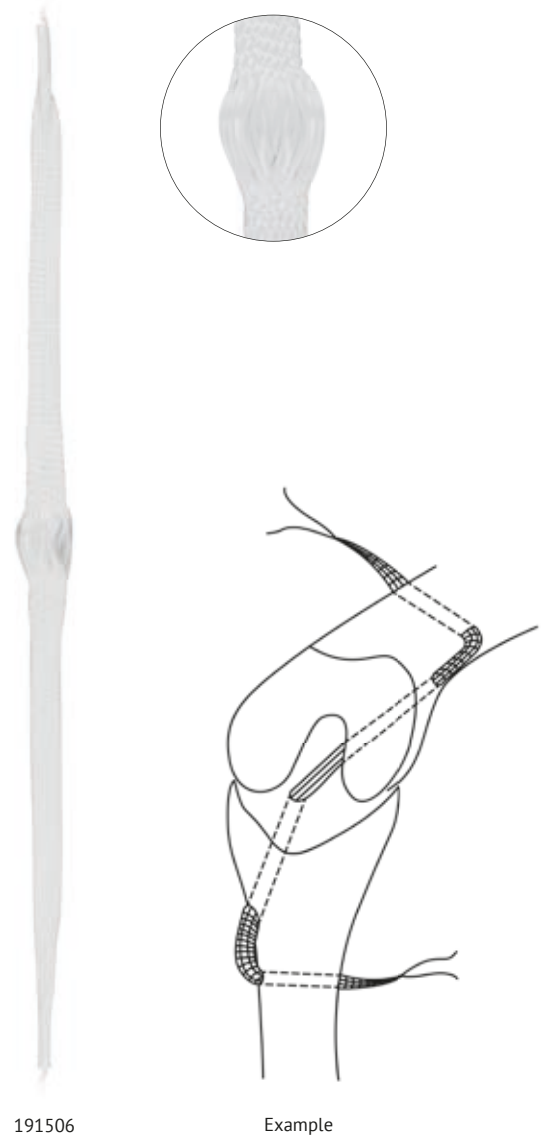

191506

Example

# ZLIG INTRA-ARTICULAR CRUCIATE LIGAMENT REPLACEMENT – COMPONENTS

## The instrumentation

A small and inexpensive set of instruments is required to perform this new and innovative cruciate ligament surgery method. The threads of the specially developed titanium interference screws are round so they do not cause any damage to the fibres of the Zlig.

## Titanium Interference Screws

- ▶ Cannulated
- ▶ 4 Titanium Interference Screws Ø 3.0 mm, blue (8 mm)
- ▶ 12 Titanium Interference Screws Ø 3.5 mm, light blue (from 8 – 13 mm)
- ▶ 12 Titanium Interference Screws Ø 4.0 mm, magenta (from 8 – 13 mm)
- ▶ 16 Titanium Interference Screws Ø 4.5 mm, gold (from 10 – 25 mm)
- ▶ 8 Titanium Interference Screws Ø 5.0 mm, green (15 & 20 mm)
- ▶ 8 Titanium Interference Screws Ø 6.0 mm, silver (10 & 20 mm)

**191535 – 191538 / 191540 – 191542 / 191545 – 191548 / 191563 / 191566 – 191568**

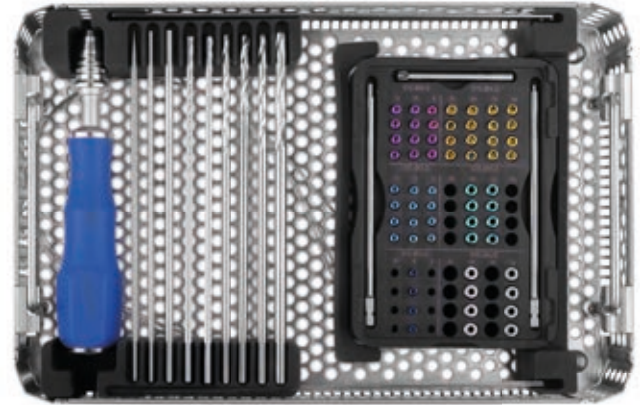

191508



191535



191538



191540



191545



191566



191567



# ZLIG INTRA-ARTICULAR CRUCIATE LIGAMENT REPLACEMENT – REFERENCE CHART

## Advice:













Use the contents of this chart as a general guideline only:

- The drill hole always depends on in situ bone stock; choose drill size accordingly.
- Use K-Wire (trocar) to perform the initial bone hole.
- After the hole in the bone has been made, open up the cortex with the recommended drill, based on the size of the ligament.

## Attention:

The blunt K-Wire for screws is a guide for the screw, to be placed parallel to the ligament.

- The blunt K-Wire is a guide for the screws (in order not to damage ligament fibres)
- How deep the guide wire is introduced into the hole should not exceed the length of the screw
- Care should be taken when introducing the screw over the guide wire (to avoid the pin being pushed into the joint, or it sticking out at the edge of the bone)
- If this were to occur due to a long guide wire, the wire will twist and be difficult to remove once the screw is in place
- The guide wire size for screws 3.0 to 4.5 is 1.0mm only

Ligament Ref.	Drill Size	K-Wire Size for Drill	Screw Size	K-Wire Size for Screws	Screwdriver Tip Size	Dog Size
CCL16/10 10 mm fibre length	Drill Ø 2.5 mm, cannulated 	K-Wire, Ø 1.0 mm, double trocar 	Screw Ø 3.0 (blue) Length: 5/8/10 mm 	K-Wire Ø 1.0 mm, double blunt 	Hex 2.0 	5–8 kg
CCL24/15 15 mm fibre length	Drill Ø 3.0 mm, cannulated	K-Wire, Ø 1.0 mm, double trocar	Screw Ø 3.0 (blue) Length: 5/8/10 mm  Screw Ø 3.5 (light blue) Length: 8/10/13 mm 	K-Wire Ø 1.0 mm, double blunt	Hex 2.0	8–12 kg
CCL32/17 17 mm fibre length	Drill Ø 3.6 mm, cannulated	K-Wire, Ø 1.8 mm, double trocar	Screw Ø 3.5 (light blue) Length: 8/10/13 mm  Screw Ø 4.0 (magenta) Length: 8/10/13/18 mm 	K-Wire Ø 1.0 mm, double blunt	Hex 2.0	12–25 kg
CCL48/19 19 mm fibre length	Drill Ø 4.2 mm, cannulated	K-Wire, Ø 1.8 mm, double trocar	Screw Ø 4.0 (magenta) Length: 8/10/13/18 mm  Screw Ø 4.5 (gold) Length: 10/15/20/ 25/30 mm 	K-Wire Ø 1.0 mm, double blunt	Hex 2.0	25–45 kg
CCL48/22 22 mm fibre length	Drill Ø 4.2 mm, cannulated	K-Wire, Ø 1.8 mm, double trocar	Screw Ø 4.5 (gold) Length: 10/15/20/25/30 mm Screw Ø 5.0 (green) Length: 10/15/20/25/30/35 mm Screw Ø 6.0 (silver) Length: 10/15/20/25/30/35 mm 	K-Wire Ø 1.0 mm, double blunt K-Wire Ø 1.8 mm, double blunt K-Wire Ø 1.8 mm, double blunt	Hex 2.0 Hex 2.5 or use Hex K-Wire Hex 2.5 or use Hex K-Wire	25–45 kg
CCL48/25 25 mm fibre length	Drill Ø 4.2 mm, cannulated	K-Wire, Ø 1.8 mm, double trocar	Screw Ø 4.5 (gold) Length: 10/15/20/25/30 mm Screw: Ø 5.0 (green) Length 10/15/20/25/30/35 mm Screw: Ø 6.0 (silver) Length 10/15/20/25/30/35 mm 	K-Wire Ø 1.0 mm, double blunt K-Wire Ø 1.8 mm, double blunt K-Wire Ø 1.8 mm, double blunt	Hex 2.0 Hex 2.5 or use Hex K-Wire Hex 2.5 or use Hex K-Wire	25–45 kg
	Drill Ø 4.0 mm, non-cannulated for tunnels which do not need to be guided (transversal tunnel)					



## ZLIG INTRA-ARTICULAR CRUCIATE LIGAMENT REPLACEMENT – ITEM LIST

Zlig Screw and Instrument Set		
Item No.	Description	Quantity
191508	Complete set, consisting of:	
191510	Zlig Instrument Tray, without instruments	1
191530	Interference Screw Container, with lid, without screws	1
191511	Twist Drill, Ø 2.5 mm, cannulated, Ø cannulation 1.2 mm, round shaft	1
191512	Twist Drill, Ø 3.0 mm, cannulated, Ø cannulation 1.2 mm, round shaft	1
191516	Twist Drill, Ø 3.6 mm, cannulated, Ø cannulation 2.2 mm, round shaft	1
191514	Twist Drill, Ø 4.2 mm, cannulated, Ø cannulation 2.2 mm, round shaft	1
191515	Twist Drill, Ø 5.0 mm, cannulated, Ø cannulation 2.2 mm, round shaft	1
191513	Twist Drill, Ø 4.0 mm, not cannulated, round shaft	1
191957	Screwdriver Blade, Hex 2.0, cannulated, AO Quick Coupling	1
191509	Screwdriver Blade, Hex 2.5, cannulated, AO Quick Coupling	1
191958	Silicone Screwdriver Handle, cannulated, AO Quick Coupling, L 140 mm	1
191517	Hexagon KIRSCHNER Wire, SW 2.5, L 150 mm	1
191518	Attachment for hexagon KIRSCHNER Wire, Hex 2.5, AO Quick Coupling	1
191519	KIRSCHNER Wire, Ø 1.0 x L 190 mm, trocar / trocar	2
191520	KIRSCHNER Wire, Ø 1.0 x L 190 mm, blunt / blunt	2
191521	KIRSCHNER Wire, Ø 1.8 x L 190 mm, trocar / trocar	2
191522	KIRSCHNER Wire, Ø 1.8 x L 190 mm, blunt / blunt	2
191524	Tube for Wire Loop, Ø 2.5 x L 150 mm, cannulated, Ø cannulation 2.0 mm	1
191525	Tube for Wire Loop, Ø 3.5 x L 150 mm, cannulated, Ø cannulation 2.5 mm	1
191926	Wire Loop, Ø 0.5 x L 600 mm	2
191535	Titanium Interference Screw, Ø 3.0 x L 8 mm, cannulated, Ø cannulation 1.1 mm, blue, Hex 2.0	4
191538	Titanium Interference Screw, Ø 3.5 x L 8 mm, cannulated, Ø cannulation 1.1 mm, light blue, Hex 2.0	4
191536	Titanium Interference Screw, Ø 3.5 x L 10 mm, cannulated, Ø cannulation 1.1 mm, light blue, Hex 2.0	4
191537	Titanium Interference Screw, Ø 3.5 x L 13 mm, cannulated, Ø cannulation 1.1 mm, light blue, Hex 2.0	4
191540	Titanium Interference Screw, Ø 4.0 x L 8 mm, cannulated, Ø cannulation 1.1 mm, magenta, Hex 2.0	4
191541	Titanium Interference Screw, Ø 4.0 x L 10 mm, cannulated, Ø cannulation 1.1 mm, magenta, Hex 2.0	4
191542	Titanium Interference Screw, Ø 4.0 x L 13 mm, cannulated, Ø cannulation 1.1 mm, magenta, Hex 2.0	4
191545	Titanium Interference Screw, Ø 4.5 x L 10 mm, cannulated, Ø cannulation 1.1 mm, gold, Hex 2.5	4
191546	Titanium Interference Screw, Ø 4.5 x L 15 mm, cannulated, Ø cannulation 1.1 mm, gold, Hex 2.5	4
191547	Titanium Interference Screw, Ø 4.5 x L 20 mm, cannulated, Ø cannulation 1.1 mm, gold, Hex 2.5	4
191548	Titanium Interference Screw, Ø 4.5 x L 25 mm, cannulated, Ø cannulation 1.1 mm, gold, Hex 2.5	4
191566	Titanium Interference Screw, Ø 5.0 x L 15 mm, cannulated, Ø cannulation 2.9 mm, green, Hex 2.5	4
191568	Titanium Interference Screw, Ø 5.0 x L 20 mm, cannulated, Ø cannulation 2.9 mm, green, Hex 2.5	4
191563	Titanium Interference Screw, Ø 6.0 x L 10 mm, cannulated, Ø cannulation 2.9 mm, silver, Hex 2.5	4
191567	Titanium Interference Screw, Ø 6.0 x L 20 mm, cannulated, Ø cannulation 2.9 mm, silver, Hex 2.5	4

Optional Accessories		
Item No.	Description	Quantity
191531	Titanium Interference Screw, Ø 3.0 x L 5 mm, cannulated, Ø cannulation 1.1 mm, blue, Hex 2.0	1
191533	Titanium Interference Screw, Ø 3.0 x L 10 mm, cannulated, Ø cannulation 1.1 mm, blue, Hex 2.0	1
191572	Titanium Interference Screw, Ø 4.0 x L 18 mm, cannulated, Ø cannulation 1.1 mm, magenta, Hex 2.0	1
191573	Titanium Interference Screw, Ø 4.5 x L 30 mm, cannulated, Ø cannulation 1.1 mm, gold, Hex 2.5	1
191544	Titanium Interference Screw, Ø 5.0 x L 10 mm, cannulated, Ø cannulation 2.9 mm, green, Hex 2.5	1
191564	Titanium Interference Screw, Ø 5.0 x L 25 mm, cannulated, Ø cannulation 2.9 mm, green, Hex 2.5	1
191574	Titanium Interference Screw, Ø 5.0 x L 30 mm, cannulated, Ø cannulation 2.9 mm, green, Hex 2.5	1
191575	Titanium Interference Screw, Ø 5.0 x L 35 mm, cannulated, Ø cannulation 2.9 mm, green, Hex 2.5	1
191565	Titanium Interference Screw, Ø 6.0 x L 15 mm, cannulated, Ø cannulation 2.9 mm, silver, Hex 2.5	1
191569	Titanium Interference Screw, Ø 6.0 x L 25 mm, cannulated, Ø cannulation 2.9 mm, silver, Hex 2.5	1
191570	Titanium Interference Screw, Ø 6.0 x L 30 mm, cannulated, Ø cannulation 2.9 mm, silver, Hex 2.5	1
191571	Titanium Interference Screw, Ø 6.0 x L 35 mm, cannulated, Ø cannulation 2.9 mm, silver, Hex 2.5	1
180500	Template with V-slot, for KIRSCHNER wires Ø 0.6 – 2.5 mm and screws from 3 – 45 mm, stainless steel	1
191990	X-Ray Reference Ball Holder, Ø 25 mm, stainless steel, suitable for digital and analog systems	1

# ZLIG INTRA-ARTICULAR CRUCIATE LIGAMENT REPLACEMENT – CASE REPORT

## Case Report

**Dr. Christoph Werner**, Freilassing, Germany, February 19th, 2020  
Shih Tzu cross “Pauline”, female, 6.6 kg, 8 years, right knee

Zlig synthetic ligament used: CCL16/10 10 mm fibre length, Drill Ø 3.6 mm cannulated, screws: diagonal femur Ø 3.5 x 13 mm, transversal Ø 3.5 x 10 mm, diagonal tibia Ø 3.5 x 10 mm, transversal Ø 3.5 x 8 mm.

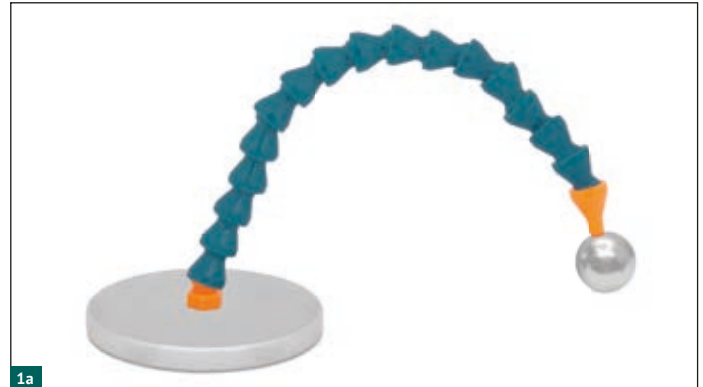

X-Ray Reference Ball Holder, Ø 25 mm (Item No. 191990), stainless steel, for implants or examining structures, using digital or analog systems (Fig. 1 and 1a).

## 1. Diagonal drill, femoral channel

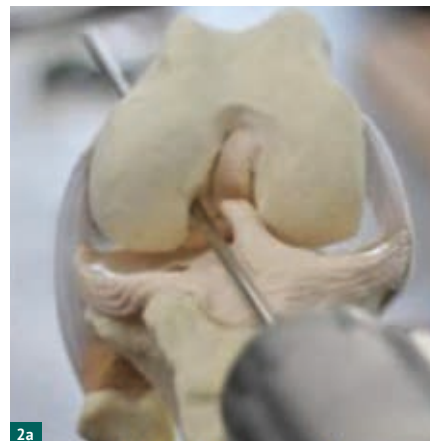
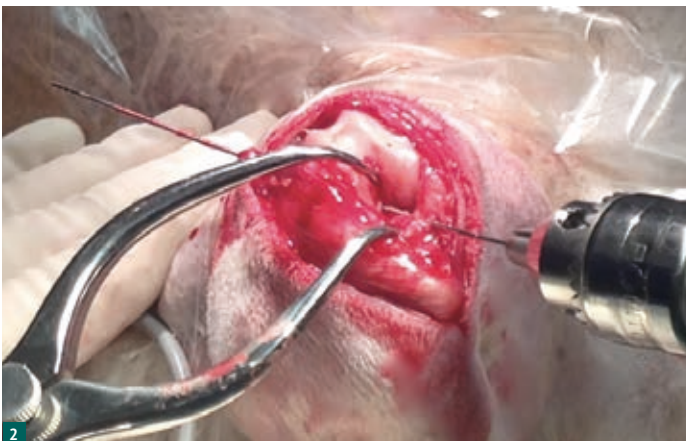

Access is performed through a medial arthrotomy, in which an incision is made in the joint capsule one centimetre medial to the patellar tendon. The patella is laterally luxated and the menisci are examined and, if necessary, resected / partially resected. The fat pad is partially removed to enable a better view if necessary. In this case, as it is a small dog, a guide KIRSCHNER wire trocar / trocar with Ø 1.0 mm (Item No. 191519) is placed in the condylar notch (otherwise use Ø 1.8 mm wire), which runs over the tibial cruciate ligament attachment. This is then drilled through the condyle to emerge on its lateral side (Fig. 2 and 2a).

### Practical tip:

The proximal attachment of the cruciate ligament can often still be seen in the intercondylar fossa. It serves as a landmark for the planned entry point of the trocar. It is important that the drilling wire lies directly on the proximal edge of the tibia with full knee flexion to achieve the necessary angle to emerge laterally from the proximal end of the trochlea.

# ZLIG INTRA-ARTICULAR CRUCIATE LIGAMENT REPLACEMENT – CASE REPORT

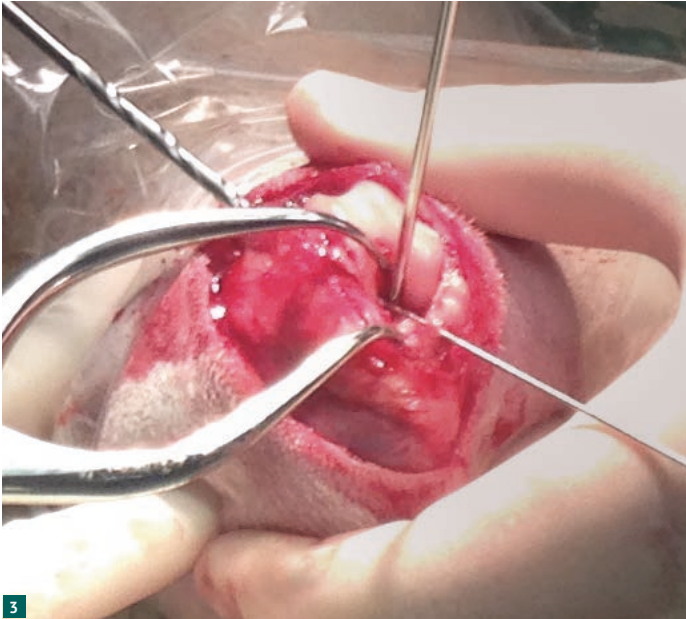

The Ø 3.6 mm cannulated drill (Item No. 191516) is then placed at the proximal end of the KIRSCHNER wire to drill a tunnel from the lateral side of the condyle towards the intracondylar notch. The hole must end just above the tibial plateau in order not to damage it. The drill is removed. The KIRSCHNER wire is left in the drilling channel (Fig. 3).

### Practical tip:

The knee should be bent as much as possible when drilling to prevent the structures of the tibial plateau from being damaged if the drill comes out too far.

### Attention:

Never insert the ligament immediately after drilling the canal through the femoral condyle, otherwise the ligament can be damaged in the second step (tibial canal).

## 2. Determine the screw length of the femoral canal

The length of the femoral canal is measured with the KIRSCHNER wire left in the drilling canal, which now acts as a depth gauge (Item No. 187737), to determine the screw length (Fig. 14 and 15). If the length of the drilling channel is between two screw lengths, the shorter screw should be selected, which is screwed in flush up to the cis cortex.

## 3. Diagonal drilling, tibial channel

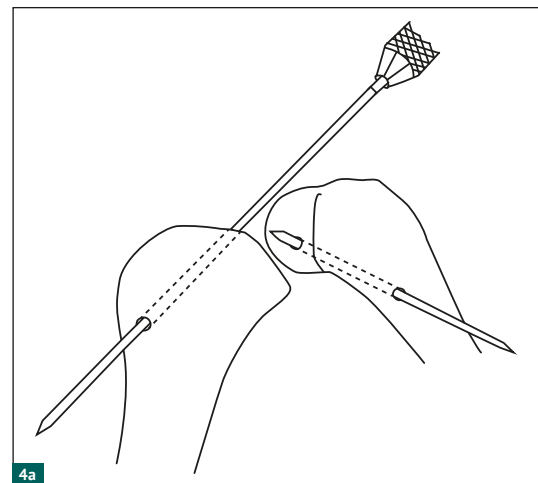

In this case the two-channel drilling technique was chosen (Fig. 4 and 4a).

The two-channel drilling technique may be necessary in some circumstances – for example, if the tibial channel cannot be drilled to a sufficient length (i. e. the hole comes out of the tibia too far distally >3 cm) via the one-channel drilling technique through the femoral bone channel. With the two-channel drilling technique, the tibia drill hole is made with the knee in full flexion. First, the Ø 1.0 mm (guide wire trocar / trocar (Item No. 191519) is placed on the tibial footprint of the anterior cruciate ligament and aligned in its inclination, so that the guide wire emerges medially about 2–3 cm below the tibial plateau. Drilling is carried out with the Ø 3.6 mm cannulated drill from the tibial plateau. This has the advantage that the structures of the knee joint (condyles, caudal cruciate ligament, etc.) cannot be damaged due to the direction of drilling. The drill is removed, the guide wire remains in the drill channel.

## 4. Pull the ligament into the joint through the tibial drilling channel



Pull the ligament into the joint through the tibial drilling channel. Starting from the tibial plateau, the Ø 2.0 mm tube is now pushed over the KIRSCHNER wire to guide the wire loop (Item No. 191524). The KIRSCHNER wire is removed. The wire loop is inserted from the tibial plateau as shown here ... (Fig. 5)

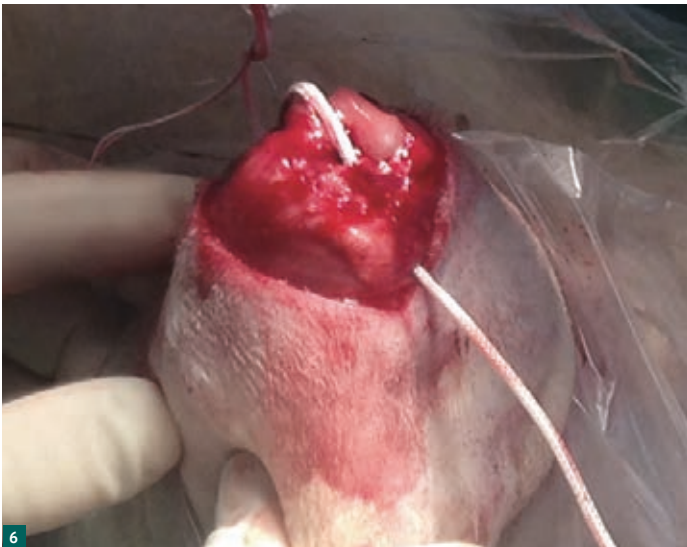

... to pull the sterile artificial ligament (Item No. 191501) into the joint from the distal end through the drill channel (Fig. 6).

## 5. Pull the ligament out of the joint through the femoral drilling channel



As before on the tibia, the Ø 2.0 mm tube (Item No. 191524) is now placed from proximal to distal in the femoral tunnel and the wire loop (Item No. 191926) is then inserted (Fig. 7).

### Practical tip:

If there are problems with the insertion of the tube: simply use the drill wire again for guidance!

## ZLIG INTRA-ARTICULAR CRUCIATE LIGAMENT REPLACEMENT – CASE REPORT



The loose end of the artificial ligament is threaded into the wire loop and then pulled proximally through the femoral drilling channel (Fig. 8).

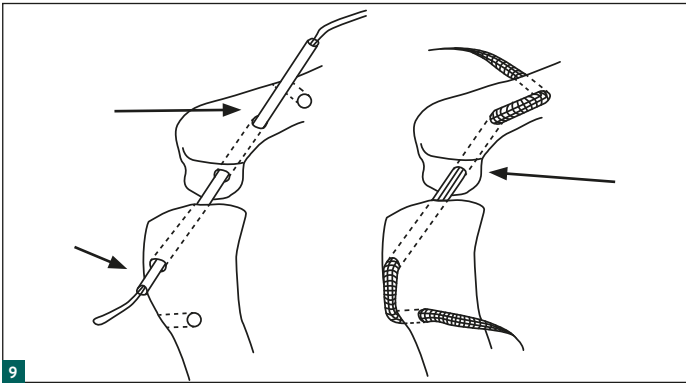

The artificial ligament is aligned (image). The loose free fibres of the ligament are placed intra-articularly (Fig. 9).

### 6. Determine the screw length of the femoral canal

The length of the femoral canal was previously measured with a depth gauge (Item No. 187737) to determine the screw length (Fig. 14 and 15). If the length of the drilling channel is between two screw lengths, the shorter screw should be selected, which is screwed in flush up to the cis cortex.

### 7. Place the guide wire for the screw

Here you see the KIRSCHNER wire blunt / blunt Ø 1.0 mm (Item No. 191520). The guide wire should only be inserted according to the measured screw length so that it does not drive into the joint when the screw is screwed in. The screw is carefully screwed in over this guide wire.

#### Important:

The blunt KIRSCHNER wire is positioned laterally from and parallel to the synthetic band in the drill channel. It is therefore located laterally to the replacement ligament. This prevents the ligament from running over the screw head later, which could lead to fraying.

#### Practical tip:

The start and end of the free fibres on the ligament can be marked with an operating marker. This makes it easier to identify them when in the knee joint!

## 8. Screw in the femoral canal screw

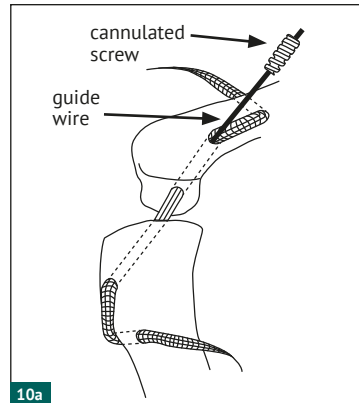
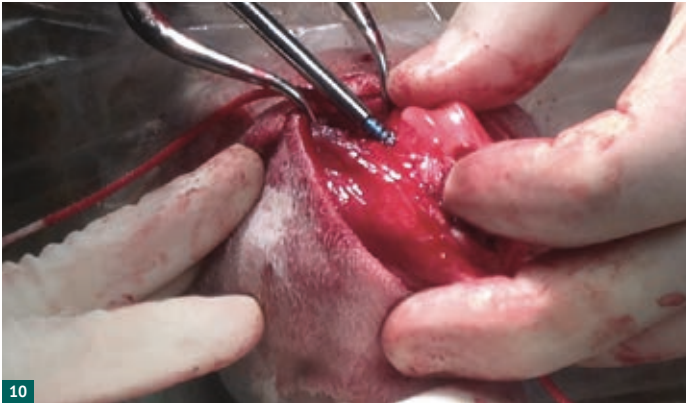

The length of the drill channel determines the screw length. The thickness is determined by the drill used. The  $\text{\O} 3.5 \times 13$  mm cannulated interference screw is screwed over the blunt guide wire with the cannulated screwdriver onto the lateral condyle until it lies flush with the bone (Fig. 10 and 10a).

## 9. Transverse drilling, femoral channel

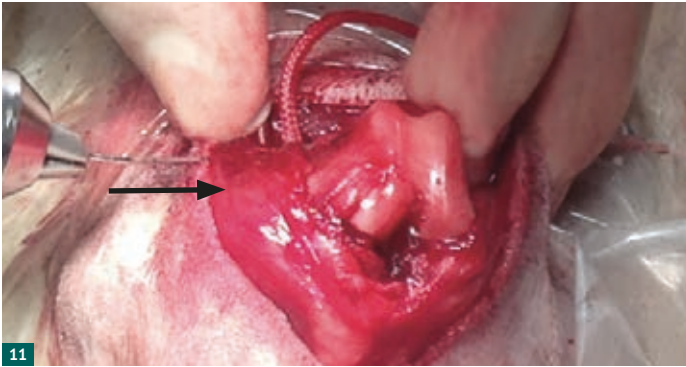

The transverse drill channel in the femur is prepared. Here the  $\text{\O} 1.0$  mm KIRSCHNER trocar / trocar wire is drilled into the femoral metaphysis one or two centimetres above the tunnel from lateral to medial (Fig. 11) ...



... and then drilled with the  $\text{\O} 3.6$  mm cannulated drill (Fig. 12).

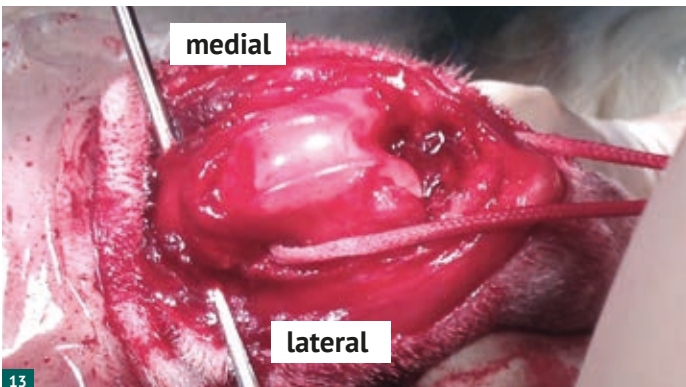

The drill is removed while the  $\text{\O} 1.0$  mm guide wire remains in the drill channel. The  $\text{\O} 2.0$  mm tube for guiding the wire loop is pushed over it from the medial side. The wire loop (Item No. 191926) is inserted from the medial side, the free end of the band is inserted into the end of the loop and then pulled medially through the tube. The tube is removed (Fig. 13).

### Practical tip:

Make sure that the ligament does not "twist". For safety, a longitudinal mark can be made on one side of the band with an operating marker pen before starting the operation!

## ZLIG INTRA-ARTICULAR CRUCIATE LIGAMENT REPLACEMENT – CASE REPORT

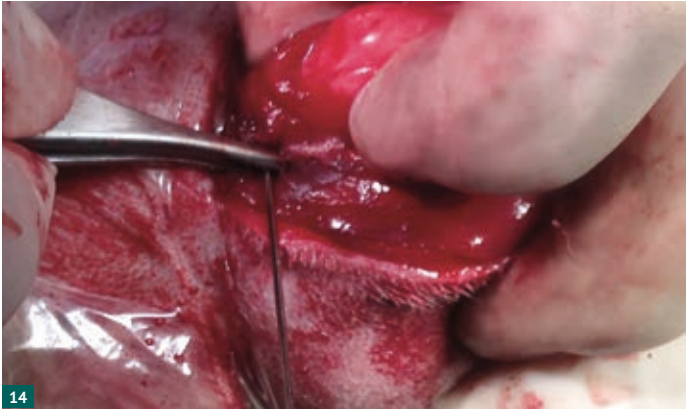

The Ø 1.0 mm blunt / blunt KIRSCHNER wire is inserted into the transverse drill hole to measure its length. Check at the exit point with the finger whether the KIRSCHNER wire appears in the drill hole: the entry point of the wire is fixed with a forceps (Fig. 14).



The length of the bone canal can thus be easily determined (here using the V-slot template, Item No. 180500). It determines the length of the interference screw (Fig. 15).

### Practical tip:

It is advisable to determine the lengths of all drill channels and have them noted!



Next the Ø 3.5 x 10 mm screw is screwed in laterally with the cannulated screwdriver (Item No. 191958) and the cannulated screwdriver blade (Item No. 191957) over the guide KIRSCHNER wire. Please note that this time the screw is inserted proximally from the band (see Fig. 9)! The ligament is kept under tension on the opposite side (Fig. 16).

## 10. Screw in the transverse femoral screw

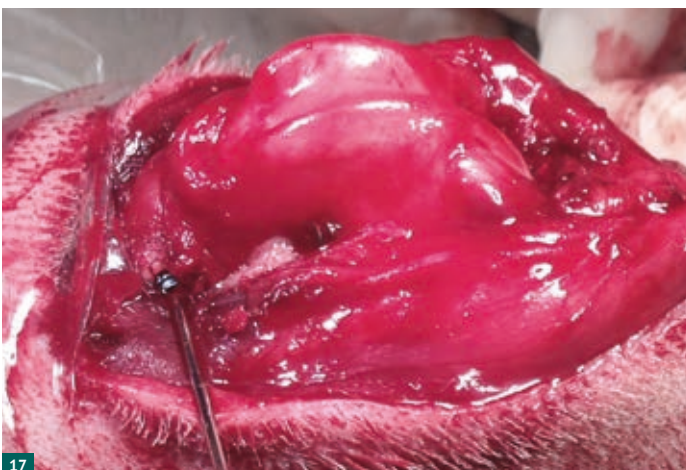

The interference screw is screwed into the transverse femoral tunnel until it is flush with the bone. The free end of the replacement ligament is then cut off medially near the bone surface (Fig. 17).

# ZLIG INTRA-ARTICULAR CRUCIATE LIGAMENT REPLACEMENT – CASE REPORT

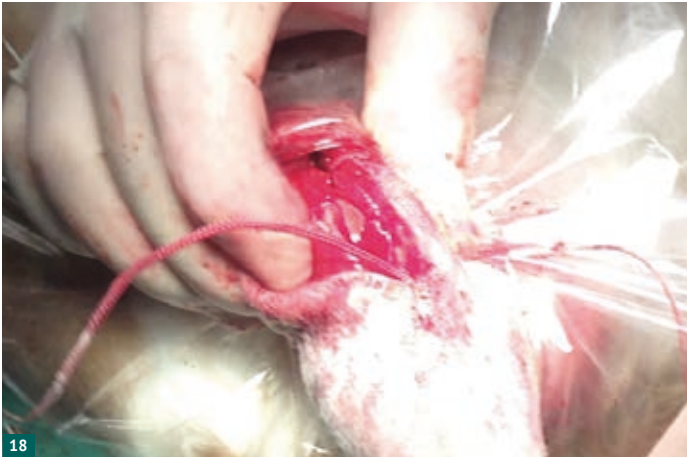

The knee joint is then rinsed with plenty of sterile saline solution. The patella is placed in the trochlea (Fig. 18).

## 11. Checking the anterior drawer ...

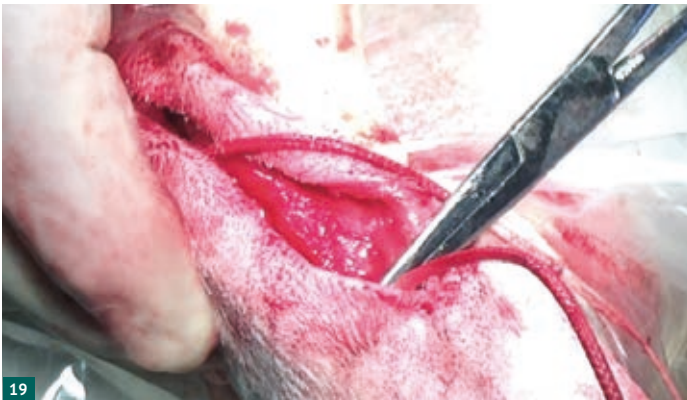

The knee joint is positioned in a 130° flexion. The free, loose ligament end at the tibia exit is held under tension with a clamp while the knee joint is extended and flexed to check whether the tension of the ligament allows the joint to move freely. The removal of the anterior drawer is checked (Fig. 19).

## 12.... and isometry

The clamp is released, and the ligament is held under tension with the thumb and index finger directly at the exit. The previous step is repeated. The ligament must not tighten or loosen under flexion and extension – this is the only way to ensure that the isometric nature of the ligament has been reached!

## 13. Screw in the tibial canal screw



The clamp is removed, the knee remains in the 130° position and the ligament is held distally under tension. This facilitates insertion of the blunt guide wire proximal to the ligament. The cannulated interference screw, whose length is measured as before can now be screwed into the drill channel via this guide wire to secure the band (Fig. 20).

### Practical tip:

The blunt guide wire can also be used to check whether the screw protrudes into the joint gap by inserting it into the drill hole from the proximal end.



## 14. Transverse drilling, tibial channel

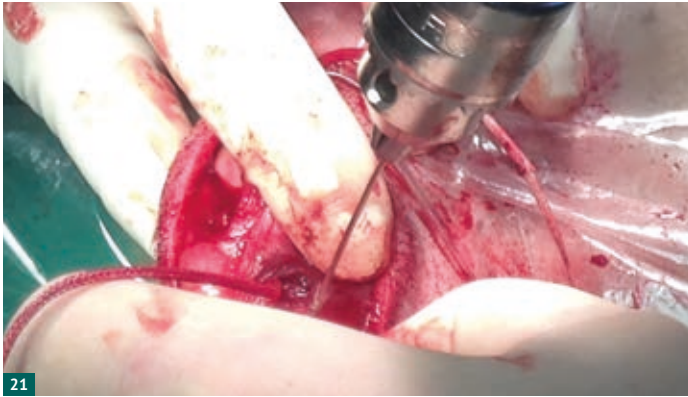

The transverse drill channel through the tibia is first made with the drill wire 1 cm below the exit of the ligament replacement. Then it is widened to Ø 3.6 mm with the cannulated drill (Fig. 21).

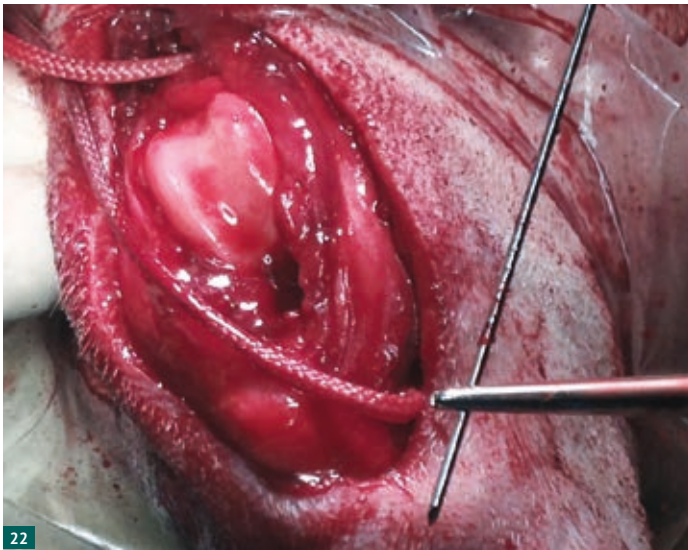

The interference screw length is again determined using a KIRSCHNER wire (Fig. 22).



The drill is removed while the guide wire with a diameter of 1.0 mm is left in the bone canal. The Ø 2.0 mm tube is pushed over it. The wire loop (Item No. 191926) is inserted laterally, the free end of the band is placed in the end of the loop and pulled laterally through the drill hole (Fig. 23).

## 15. Screw in the transverse tibial screw

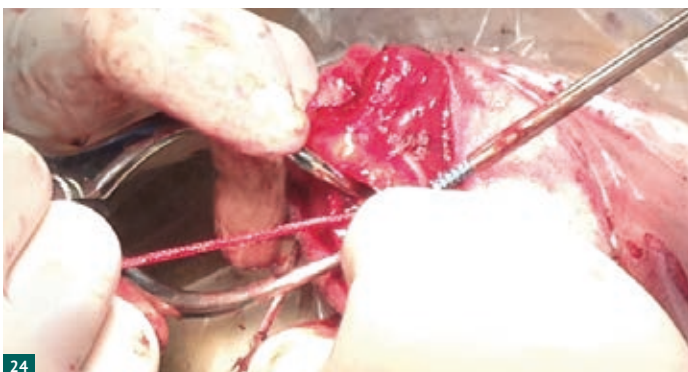

The thickness of the cannulated interference screw is determined by the bone canal, in this case a Ø 3.5 mm x 8 mm screw. The guide wire is inserted from the medial side of the tibia. It is important that this time it runs distal to the ligament replacement. The screw is screwed in until it is flush with the bone surface. Both loose ends of the ligament can now be cut close to the bone (Fig. 24).

## 16. Wound closure

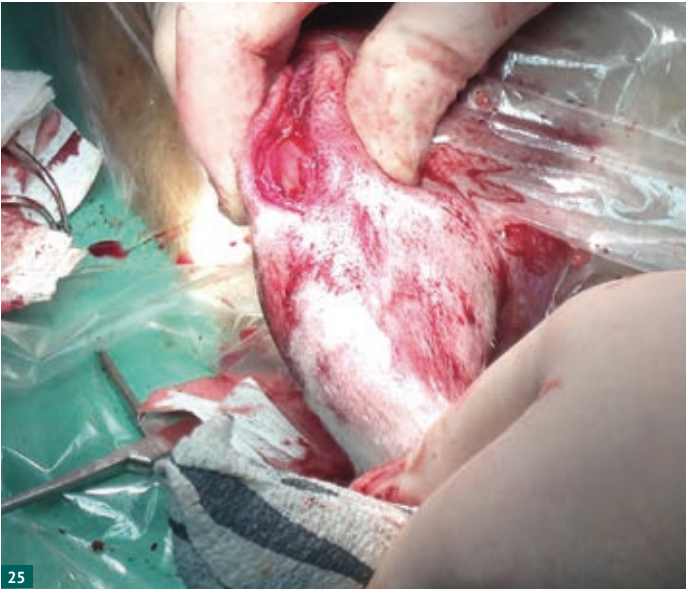

The joint capsule, the fascia and the subcutaneous tissue are sutured with absorbable suture, the skin is closed with non-absorbable suture material (Fig. 25).



Lateral view (Fig. 26)



Enlarged section of Fig. 26 Lateral view (Fig. 26a)

## ZLIG INTRA-ARTICULAR CRUCIATE LIGAMENT REPLACEMENT – CASE REPORT

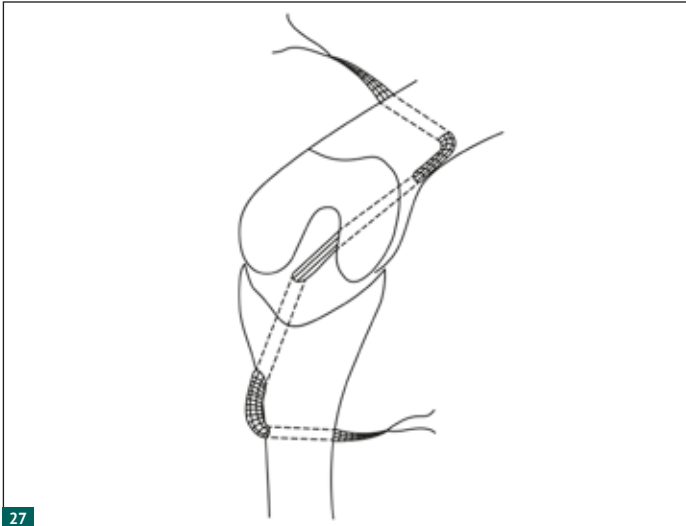

This Z-shaped arrangement is mechanically very strong. It enables the immediate resumption of joint activity in every dog (Fig. 27).

27

Lateral view (Fig. 28)



28

Lateral view with X-Ray reference sphere Ø 25 mm (Item No. 191990) (Fig. 29)



29

# ZLIG INTRA-ARTICULAR CRUCIATE LIGAMENT REPLACEMENT – CASE REPORT

---



Frontal view (Fig. 30)

**Dr. Christoph Werner**  
Tierärztliche Gemeinschaftspraxis  
Lohenstraße 5  
83395 Freilassing

# ZLIG INTRA-ARTICULAR CRUCIATE LIGAMENT REPLACEMENT – VIDEOS

---

## Zlig application video



## Zlig post-operative videos



German Shepherd Cross  
"Lieserl"



Labrador Retriever  
"Bonny"



Shih Tzu  
"Pauline"



Cocker Spaniel  
"Indie"

# EickLoxx SPP<sup>®</sup>

Innovative Patellar Luxation System

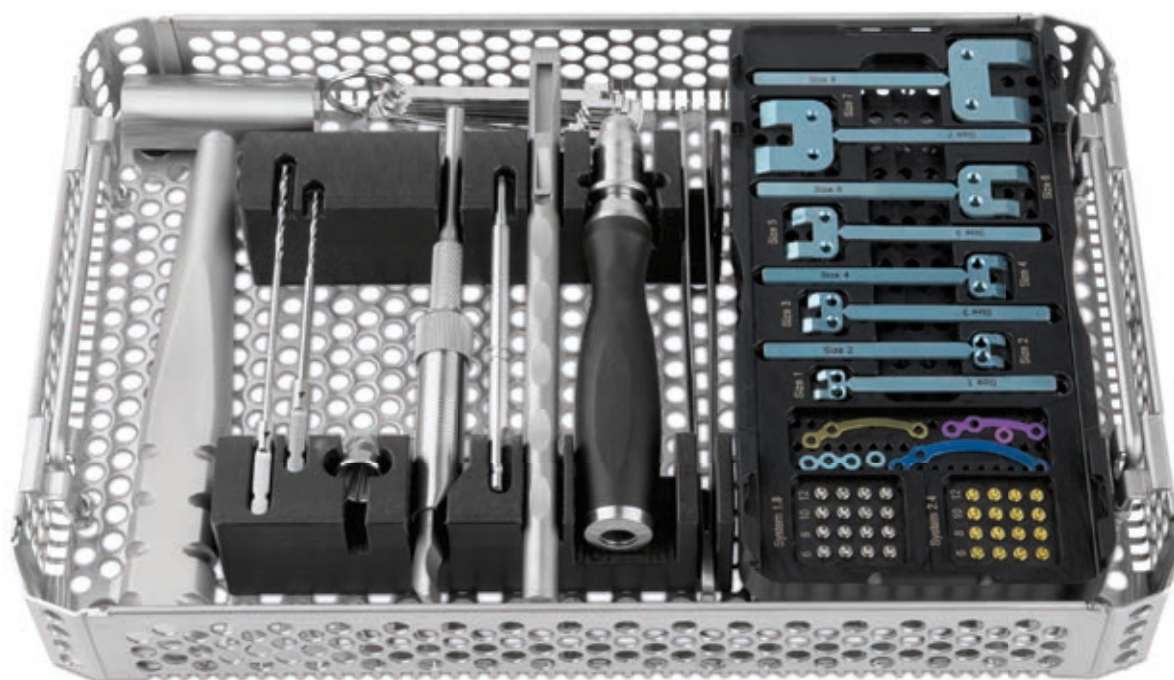

## EICKLOXX SPP® PATELLAR LUXATION SYSTEM – CHARACTERISTICS

The EickLoxx SPP® (Swiss Patella Plate®) system is a new technique in the treatment of medial patellar dislocation in dogs and cats.

In the surgical treatment of patellar luxation in small animals, a tension band is usually inserted to fix the osteotomised tibial tuberosity. When a band is fitted, the ends of the KIRSCHNER wires can irritate the skin, or the implants might migrate, requiring them to be removed. The new EickLoxx SPP® impact plate is intended to avoid revision surgeries.

The EickLoxx SPP® system consists of 8 different plate sizes, 4 locking plates, 2 washers and multiaxial Ø 1.7 mm and Ø 2.3 mm locking screws which, depending on the bone size, can be screwed into the plate. This enables a good anatomical fit and stable fixation.

### Titanium Locking Screw

- ▶ Self-cutting / self-drilling
- ▶ 16 titanium locking screws Ø 1.7 mm, silver (from 6 – 12 mm)
- ▶ 28 titanium locking screws Ø 2.3 mm, gold (from 6 – 12 mm)

**185521 – 185523 / 185528 – 185530 / 185557 / 185559**

### Properties

- ▶ Surgical correction of the patellar dislocation using an impact plate
- ▶ Stable fixation enables faster postoperative recovery
- ▶ Biocompatible titanium (no removal of the plate is necessary)

### The technology

Due to the stable fixation of the SPP® plate using two multi-directional locking screws, and the use of implants on the medial side, the rate of revision surgeries is greatly reduced. The impact plate reliably prevents the medial displacement of the tibial tuberosity.



197200

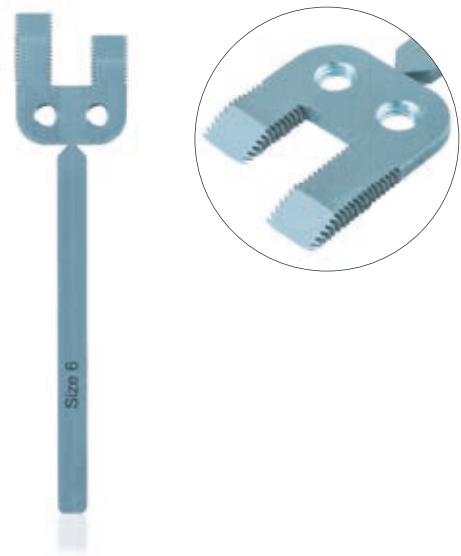

197225



185523



185530

# EICKLOXX SPP® PATELLAR LUXATION SYSTEM – SURGICAL TECHNIQUE

## Surgical technique with the Swiss Patella Plate® (SPP®)

### Step 1: Preparatory measures

To determine the plate size, a template is placed on the lateral X-Ray of the proximal tibia (Fig. 1). The optimal impact plate has foot lengths that do not touch the caudal cortex after impact. The middle of the cranial edge should be roughly level with the proximal end of the cranial margin and allow for two screws to be safely inserted into the osteotomised segment.

The choice of the correct Swiss Patella Plate® (SPP®) can be determined using the chart below (Fig. 3). It may be possible to choose between several plate sizes depending on the body shape and size of the patient. Therefore the implant should be chosen as described above, and why the correct size should be checked on the X-Ray before and during the operation. For this reason, a set of test plates is also available (Fig. 2).

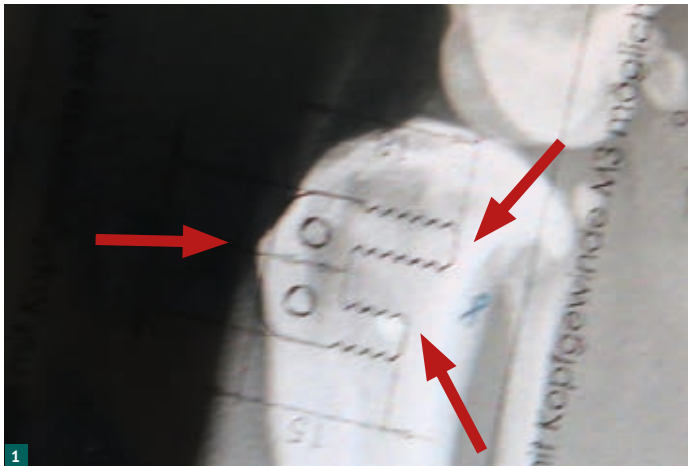

Plate:	1		3			5		7						
			2		4		6		8					
Locking Plate:	light blue		magenta		gold		dark blue							
Screws:	1.7 mm					2.3 mm								
kg:	1	2	3	4	5	6	7	8	9	10	15	20	25	30+

Fig. 1: Planning the plate size on the X-Ray image

Fig. 2: Planning the plate size with the test plates

Fig. 3: Guidelines for choosing the Swiss Patella Plate® (SPP®) implants

### Step 2: Access

A medial approach to the knee joint is recommended when using the Swiss Patella Plate® (SPP®). Sulcoplasty is often recommended, especially in cases which have higher degrees of patellar luxation. This can be done as a wedge or block technique in dogs. The SPP® technique requires approximately one third of the medial tibia to be exposed. To do this, the medial fascia over the middle of the tibial shaft is incised and the muscles that are medial to it are retracted in a caudal direction.

### Step 3: Surgical steps for the insertion and fixation of the Swiss Patella Plate® (SPP®)

- Planning the osteotomy: The selected impact plate is placed on the medial proximal tibia as planned on the X-Ray (Fig. 4). The plate should be perpendicular to the longitudinal axis of the tibia. The centre of the plate should be roughly level with the proximal edge of the cranial margin. If between sizes, and where feasible, the larger plate should be chosen.
- Marking the osteotomy: The osteotomy follows a line cranially to the menisci, along the base of the plate, and resembles a curve to cranial on the distal side of the plate (Fig. 5). In the case of very small dogs, it should be ensured that the osteotomy is sufficiently caudal; if not, too little endosteal width will be available for the implant. The osteotomy line can then be marked (scalpel blade, electrocautery) (Fig. 6).
- Osteotomy: It is recommended that the osteotomy be performed with an oscillating saw and a short narrow blade (Fig. 7). Cool with a sterile water wash proximally to distally.

# EICKLOXX SPP® PATELLAR LUXATION SYSTEM – SURGICAL TECHNIQUE

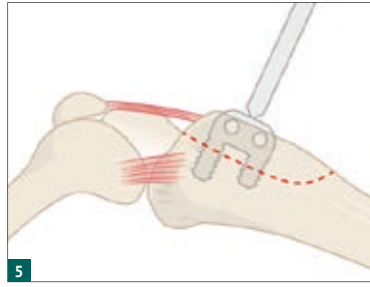

Fig. 4: Planning the osteotomy

Fig. 5: Planning the osteotomy, incision (red)

Fig. 6: Marking of the osteotomy line

Fig. 7: Use of the oscillating saw, incision from proximal to distal

d. Driving in the Swiss Patella Plate®: The plate (with the bar attached) is inserted, using the driving aid, in such a way that the protrusion of the aid does not cause pressure on the osteotomised segment. The plate is inserted with a hammer, perpendicular to the longitudinal axis, through the cancellous bone of the proximal tibia (Fig. 8), ensuring that the proximal foot penetrates before the distal one (Figs. 9 and 10).

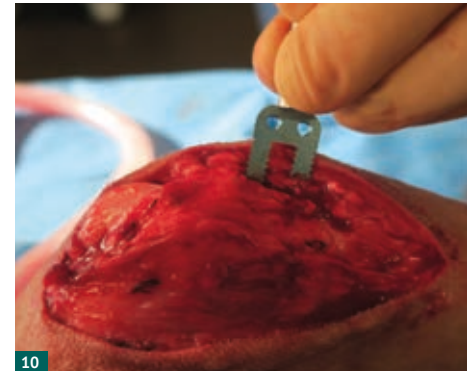
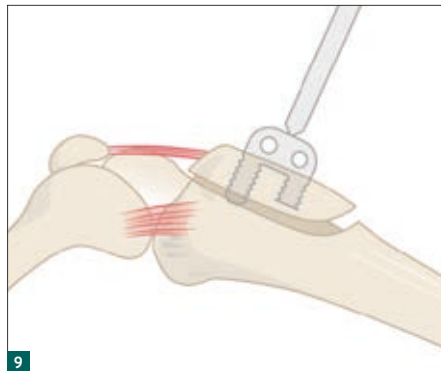

Fig. 8: Driving in the Swiss Patella Plate® (SPP®) with a hammer

Fig. 9: The proximal foot must grasp first

Fig. 10: The first foot has taken hold, the direction of the plate is left unchanged

e. Depending on the lateralisation of the impact plane and the angle of the plate, more or less lateralisation of the tibial tuberosity can be achieved (Fig. 11).

f. The bar is broken off by kinking (Fig. 12).

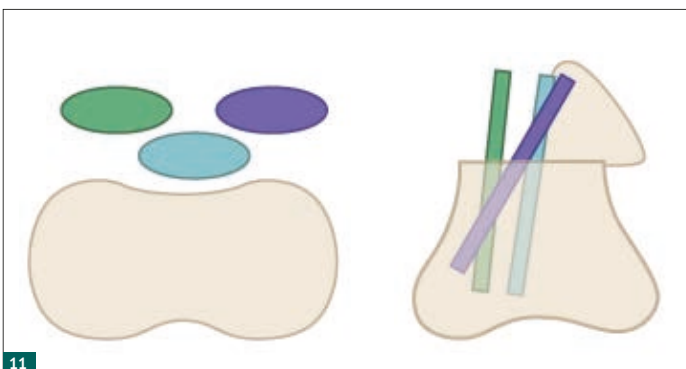

Fig. 11: Possibilities for lateralisation

Fig. 12: Kinking of the bar



# EICKLOXX SPP® PATELLAR LUXATION SYSTEM – SURGICAL TECHNIQUE

## Step 4: Fixation of the plate

To prevent the quadriceps muscle from pulling the plate out of the tibia, the plate is attached to the osteotomised tibial tuberosity and the tibial shaft.

- The tibial tuberosity is placed on the plate with bone grasping forceps and fixed to the tibia. The proximal hole of the screw is drilled with a  $\varnothing$  1.4 mm or  $\varnothing$  1.8 mm drill bit; the screw with the corresponding length ( $\varnothing$  1.7 mm or  $\varnothing$  2.3 mm) is inserted and fully tightened.
- The appropriate size locking plate is selected. The third eyelet, in the locking plate, serves to compensate for the misalignment caused by the osteotomised tuberosity. Optional: With heavier dogs it is also possible to use the securing plate fixed distally with 2 screws.
- As described above for the proximal plate, the securing plate is attached by means of a screw through the distal plate hole. The distal end is fixed to the tibial shaft with a third screw (Figs. 13, 14 and 15).

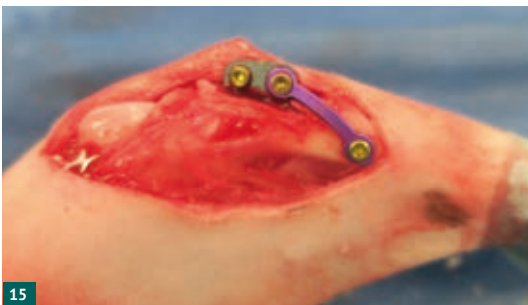
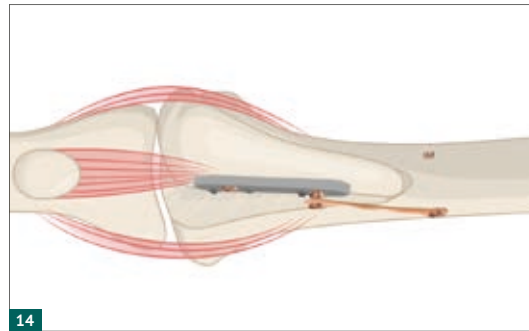
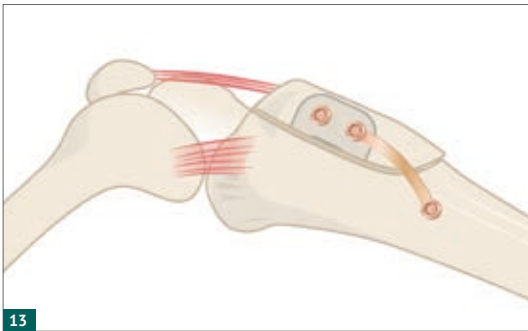

Fig. 13 and 14: Illustration of the fully assembled SPP® with safety bracket and 3 screws

Fig. 15: Fully assembled SPP® with locking plate

## Step 5: Closure

After the operation, the fit of the SPP® is checked using X-Rays (Figs. 16 and 17). Bandage therapy is not indicated. Physiotherapy increases and ensures the success of the procedure.



Fig. 16 and 17: Postoperative X-Rays after the use of an SPP®

## EICKLOXX SPP® PATELLAR LUXATION SYSTEM – ITEM LIST

EickLoxx SPP®		
Item No.	Description	Quantity
197200	Complete set, consisting of:	
197250	EickLoxx SPP® Mesh Tray, without instruments and without implants	1
197230	EickLoxx SPP® Implant Tray, without implants	1
185507	Twist Drill, Ø 1.4 mm, AO Quick Coupling	1
185508	Twist Drill, Ø 1.8 mm, AO Quick Coupling	1
185510	Screwdriver Blade, Torx 6, AO Quick Coupling	1
185515	Silicone Screwdriver Handle, cannulated, AO Quick Coupling, L 120 mm	1
185512	Drill Guide Funnel System, 1.7 / 2.3	1
185779	Plate and Screw Holding Forceps, stainless steel, angled, L 150 mm	1
197201	Depth Gauge, measuring range 30 mm, sample 1.0 mm	1
197204	EickLoxx SPP® Panel Impactor	1
197202	EickLoxx SPP® Hammer, small, L 165 mm	1
197203	EickLoxx SPP® Metal Templates, for determining the size of the patellar dislocation plates	1
197205	EickLoxx SPP® Foil Template, for determining the size of the implants, not sterilizable	1
197220	EickLoxx SPP® Patellar Dislocation Plate, size 1	1
197221	EickLoxx SPP® Patellar Dislocation Plate, size 2	1
197222	EickLoxx SPP® Patellar Dislocation Plate, size 3	1
197223	EickLoxx SPP® Patellar Dislocation Plate, size 4	1
197224	EickLoxx SPP® Patellar Dislocation Plate, size 5	1
197225	EickLoxx SPP® Patellar Dislocation Plate, size 6	1
197226	EickLoxx SPP® Patellar Dislocation Plate, size 7	1
197227	EickLoxx SPP® Patellar Dislocation Plate, size 8	1
197216	EickLoxx SPP® Locking Plate, size S, light blue	1
197217	EickLoxx SPP® Locking Plate, size M, magenta	1
197218	EickLoxx SPP® Locking Plate, size L, gold	1
197219	EickLoxx SPP® Locking Plate, size XL, dark blue	1
197210	EickLoxx SPP® Washer, Ø 0.6 mm, magenta	2
197211	EickLoxx SPP® Washer, Ø 1.6 mm, light blue	2
185557	Titanium Locking Screw, Ø 1.7 x L 6 mm, multidirectional, silver, Torx 6, self-drilling, self-tapping	4
185521	Titanium Locking Screw, Ø 1.7 x L 8 mm, multidirectional, silver, Torx 6, self-drilling, self-tapping	4
185522	Titanium Locking Screw, Ø 1.7 x L 10 mm, multidirectional, silver, Torx 6, self-drilling, self-tapping	4
185523	Titanium Locking Screw, Ø 1.7 x L 12 mm, multidirectional, silver, Torx 6, self-drilling, self-tapping	4
185559	Titanium Locking Screw, Ø 2.3 x L 6 mm, multidirectional, gold, Torx 6, self-drilling, self-tapping	4
185528	Titanium Locking Screw, Ø 2.3 x L 8 mm, multidirectional, gold, Torx 6, self-drilling, self-tapping	4
185529	Titanium Locking Screw, Ø 2.3 x L 10 mm, multidirectional, gold, Torx 6, self-drilling, self-tapping	4
185530	Titanium Locking Screw, Ø 2.3 x L 12 mm, multidirectional, gold, Torx 6, self-drilling, self-tapping	4
185554	Container, unperforated tub, including perforated lid, dimensions (in mm): L 312 x W 183 x H 65	1

# *Swiss Patella Plate® (SPP®) – a new technology for the treatment of Medial Patellar Luxation using an impact plate*

*In the current surgical treatment of patellar dislocation in small animals, a tension band is inserted, fixing the osteotomised tibial tuberosity. When a band is fitted, the ends of the KIRSCHNER wires can irritate the skin, damage the implant, or even make the implant migrate, requiring them to be removed. With the new impact plate (Swiss Patella Plate®) revision surgeries are avoided. The technology, and the experience over a year, is presented below.▶*

## Introduction

Patellar luxation (PL) is a widespread skeletal disease in dogs and cats. It occurs mainly in pre-disposed breeds (OFA, 2020). These include, among others: Chihuahua, Pug, French Bulldog, Miniature Pinscher, Poodle, Shih Tzu, Pekingese, Yorkshire Terrier, Maltese. There has been also an increase in large dogs, these include Appenzell Mountain Dogs, Flat Coated Retrievers and Newfoundlanders. The patella usually dislocates medially; very few dogs have a lateral patellar dislocation (Vidoni et al., 2005).

Dogs with PL are usually young and present with intermittent lameness in one or both hindlimbs. The diagnosis of PL is possible via palpation. It has been divided into 4 degrees (Putnam, 1968; Singleton, 1969; Koch et al., 1998). The graduation does not necessarily correlate with the clinical picture. There is no clarity about the pathogenesis of PL.

From studies on PL in Papillons (Weber, 1992) correlation could not be drawn from the anatomy of the hind leg and pelvis. The only connection was with the miniaturisation of dogs. The knee angle and shape of the femur could not be correlated with the occurrence of PL (Kaiser et al., 1997; Kaiser et al., 2001a; Kaiser et al., 2001b). Only the three-dimensional processing of images, by means of high-frequency radiography, allowed a working group (Lehmann et al., 2020) the rotation of the femur in the bracing phase with the foot and tibia fixed, demonstrating that the patella is affected by the medially directed pull of the M. quadriceps and can be pulled out of the sulcus femoris. This rotation is found especially in dogs with a wide gait, which can be found in many of the breeds listed above. The phylogenetically defined role of the patella as the original apophysis of the femur and, in most animals today, its role as a functioned free piece of bone in the M. quadriceps network, must remain unexplained for the time being. With regard to treatment, only the medial PL is discussed here.

There are different approaches, taking into consideration the degree of dislocation and the degree of discomfort. The simplest course of action consists of a tightening of the lateral joint capsule, enabling a balanced tension on the patella. This is achieved with anti-rotation sutures, of either slow or non absorbent properties. In many cases there is no sustainability. The classic treatment lies in the depression of the sulcus femoris with a wedge or block resection technique, a lateral displacement of the tibial tuberosity and fixation by means of tension straps. Different fixation methods include the introduction of a single screw or KIRSCHNER wire, if the tibial crest is not completely osteotomised. High grade PL, where the tibial crest and femur are incorrectly aligned, can also be treated with rotation osteotomies, giving a slight cranial shift (Kowaleski et al., 2012). Finally, there is the alternative approach for the extensor tendon apparatus displaced with the patella, where the femoral sulcus should be moved under the patella. For this purpose, the "Patella Groove" half-prosthesis is ideal (Dokic et al., 2015). The most common complication noted is migration of the implants used to fix the osteotomised and laterally relocated tibial tuberosity (Kowaleski et al., 2012; Cashmore et al., 2014; Bosio et al., 2017). In addition, the sharp KIRSCHNER wire end up rubbing the nearby skin and can cause lameness.

For this reason, we are introducing a new fixation method using an impact plate, the Swiss Patella Plate® (SPP®), which is

intended to prevent the implants having to be removed in a follow-up operation. This is based on the revision surgery rate with the classic method. The new technology is only suitable for medial PL.

## Surgical technique

We recommend surgical treatment of medial PL with a medial approach to the knee joint. A sulcoplasty can be carried out for a shallow femoral sulcus, via a wedge osteotomy and removing a thin deepening wedge. The osteotomy of the tibia is performed using the medial lateral X-Ray and the selected SPP® plate. The separated tibial tuberosity can accommodate 2 screws and the shaft of the tibia should be exposed sufficiently so that the plate can be fitted. The osteotomy is then completed using an oscillating saw from medial and proximal to distal. Depending on the degree of dislocation, the osteotomised tuberosity can now be shifted laterally. A lateral bend in the SPP® that is to be hammered in can increase this.

Now the plate is fixed using a special drive-in aid, hammered into the tibia from the cranial side (Fig. 1). Through a hole in the distal screw of the plate, cerclage wire is passed around the shaft of the tibia (Fig. 2 and 3). After introducing the proximal screw and the distal screw is tightened, the soft tissues can be closed, the lateral fascia near the knee is gathered and the knee is X-rayed (Fig. 4).

Postoperative bandage therapy is not necessary. 8 different plate sizes are available for treatment. The SPP® is attached with 1.7 or 2.3 mm EickLoxx locking screws. The most common cerclage wire diameters are 0.7, 0.8 and 1.0 mm.

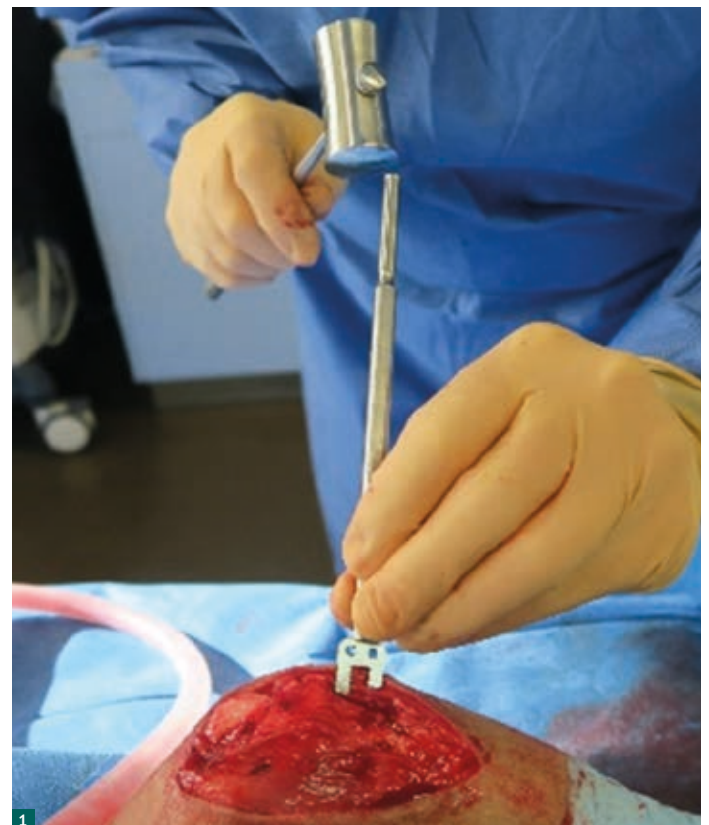

Fig. 1: Impact of the SPP® into the tibia with the aid of an impact aid.

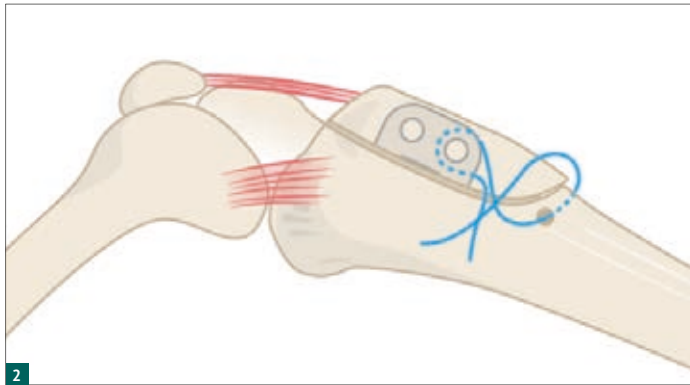

Fig. 2: Schematic view of the surgical technique with SPP®. The plate is hammered into the tibia, the cerclage wire to be applied prevents the rotation of the osteotomised and laterally displaced tibial tuberosity. The osteotomy is performed caudally and sufficiently, especially at the distal end.



Fig. 3: Intraoperative view from the cranial side: the tibial tuberosity moves laterally offset, the implanted SPP® prevents it from sliding back.

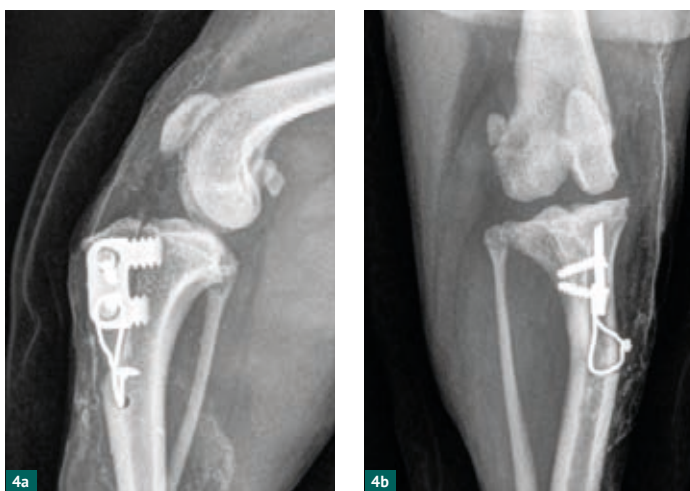

Fig. 4a and 4b: Postoperative X-Rays with a SPP® (size no.3). The cerclage wire goes around the distal screw and a hole in the tibial shaft.

## First experience with the technology

In comparison to fixation with a tension belt, where the surgeon can adjust if needed, the plate size must be preoperatively determined, facilitated with the help of a template. Because the tibial tuberosity has to accept two screws the segment should be deep enough. In dogs weighing less than 3 kg, the tibial shaft may

not be osteotomised sufficiently enough to be able to accommodate the impact plate.

In the first case of an eight-month-old dog treated with the SPP® no cerclage wire was used because it was assumed that the feet of the plate could resist the tensile forces of the quadriceps. Like the control X-Ray six weeks after showed, the tibial tuberosity rotated slightly proximally, before it grew. We also observed the same phenomenon with three dogs in which the cerclage wire was not fully drawn. Owners reported one clinical relapse with lameness a few days after the operation and a quite lengthy healing process.

## Revision surgery rate after 60 cases

The first 60 cases with an SPP® and the above technique with two fixation screws and cerclage wire were evaluated. The observation time after the operation was a minimum of three months. Four dogs had to be operated on again. In three of the dogs the wire had come loose and led to irritation of the skin and consequent lameness. There was also a dog with a reaction to the metal. The revision operation rate was therefore 6.5 %.

In contrast, the long-term rate of implant removal with our previous technique, using the tension band, was 32%, with 87 revisions out of 271 PL cases.

In another three cases with the SPP®, the wire did come loose, but the tibial tuberosity shifted minimally in the proximal direction, which is why revision surgery was not indicated. The bone healed in time and with the formation of callus.

## Discussion

In itself, surgical treatment of PL is a standard procedure (Singleton, 1969; Slocum and Devine, 1985; Harasen, 2006; Kowaleski et al., 2012). There is potential for improvement especially with a reliable estimate of the degree of lateralisation, medialisation and fixation of the implants. The classic tension band using two KIRSCHNER wires and cerclage wire carries the risk of loosening the thread free nails. One could argue that using threaded nails would get better hold. This is true, but the principle of tension banding involves one through the muscle pull and the compressive force along the KIRSCHNER wires, lightly pressing the tuberosity onto the tibia and thus promoting healing. (Schwarz, 2005). Lots of surgeons also bend the proximal ends of the KIRSCHNER wires around to minimise abrasion of the overlying fascia, subcutaneous tissue and skin. The bend cannot prevent loosening.

The alternative to the technique is that of the osteotomised tuberosity with a single screw or one individual KIRSCHNER wire. To enable this, the distal saw cut must not be fully completed – the distal end of the tuberosity should just barely touch the tibia and remain connected, thus relieving the tensile forces of the quadriceps. With such a cut, sufficient lateral displacement of the tuberosity can be limited and high levels of PL cannot be corrected as a result of this.

To address the problem of implant loosening or irritation caused implant removal and an associated second intervention, the SPP® was developed. The impact plate reliably prevents medial

backward displacement of the tuberosity. Italian surgeons had a similar idea, putting a nail in the tibia in place of the plate and attaching it to a special external fixator (Petazzoni, 2015). This fixator then had to be removed again. Thanks to the stable fixation of the SPP® using screws and the placement of all implants on the medial side, the revision rate will be greatly reduced.

The numbers from our first test series are shown. The cause of 3 revision surgeries was linked to the tensile strength and fixation of the cerclage wire. These can occasionally break during the operation and require replacement. Damage to the wire caused by asymmetrical pulling/twisting with the pliers around the screw thread can lead to such fractures. Plus, the now freer to pull M. quadriceps can rotate and add to this issue. With this in mind, choose a wire strong enough to tighten and cut, in accordance with the same principles as the working group for Osteosynthesis questions (AO) to be followed (Schwarz, 2005).

Developments introduced by the manufacturer provide alternative fixation possibilities of the wire on the plate, as well as attachment to the tibial shaft (Fig. 5).

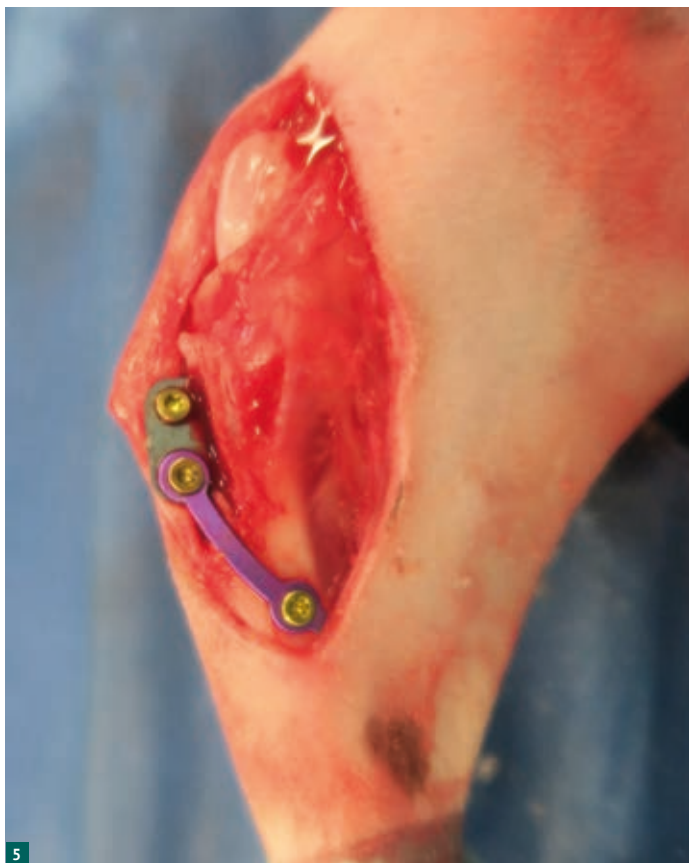

Fig. 5: The latest fixation method: the wire is secured by a titanium bracket / securing plate and screw fixation replaced

A clear limitation with the SPP® is the fact that this method is only suitable for medial PL. With a lateral PL, the tuberosity would have to be displaced medially and force surgeons to place the plate on the lateral side of the tibia. This can only be achieved through widespread deposition of the M. tibialis cranialis from the periosteum. This would mean the blood supply of the osteotomised tuberosity, especially in the important healing phase, would be

severely impaired and would loosen because the tibialis cranialis muscle pulls the M. quadriceps and counteracts this.

The technique presented here with the SPP® requires a couple of precautions. A plate cannot be arbitrarily hammered into the end of the tibial shaft, otherwise the lateral stability would be impaired due to broken cancellous bone. The osteotomy needs to be carefully planned as well as performed. It begins just above the menisci and must be wide enough at its distal end to be able to take the plate. This will be a problem, especially in small dogs under 4 kg, even if the smallest plate fits. The stable fixation of the cerclage wire between the bone and the plate and around the distal screw, and correct tensioning and twisting, do not always succeed, leading to slightly unstable conditions and delayed healing. The osteotomised tuberosity must also be handled with bone grasping forceps on the tibial shaft and laterally against the plate, which requires skill.

Overall, the new technology is easy to learn for experienced surgeons. The increased effort is worthwhile, thanks to less postoperative work and complications.

#### Literature:

1. Bosio F., Bufalari A., Peirone B., Petazzoni M., Vezzoni A. (2017): Prevalence, treatment and outcome of patellar luxation in dogs in Italy. A retrospective multicentric study (2009-2014). *Vet Comp Orthop Traumatol* 30: 364-370.
2. Cashmore R. G., Havlicek M., Perkins N. R., James D. R., Fearnside S. M., Marchevsky A. M., Black A. P. (2014): Major complications and risk factors associated with surgical correction of congenital medial patellar luxation in 124 dogs. *Vet Comp Orthop Traumatol* 27: 263-270.
3. Dokic Z., Lorinson D., Weigel J. P., Vezzoni A. (2015): Patellar groove replacement in patellar luxation with severe femoro-patellar osteoarthritis. *Vet Comp Orthop Traumatol* 28: 124-130.
4. Harasen G. (2006): Patellar luxation: pathogenesis and surgical correction. *Can Vet J* 47: 1037-1039.
5. Kaiser S., Cornely D., Golder W., Garner M., Waibl H., Brunnberg L. (2001a): Magnetic resonance measurements of the deviation of the angle of force generated by contraction of the quadriceps muscle in dogs with congenital patellar luxation. *Vet Surg* 30: 552-558.
6. Kaiser S., Cornely D., Golder W., Garner M. T., Wolf K. J., Waibl H., Brunnberg L. (2001b): The correlation of canine patellar luxation and the anteversion angle as measured using magnetic resonance images. *Vet Radiol Ultrasound* 42: 113-118.
7. Kaiser S., Waibl H., Brunnberg L. (1997): Der "Quadriceps-Winkel" in der radiologischen und magnetresonanztomographischen Darstellung: Ein Parameter zur Objektivierung der mit der Luxatio patellae congenita assoziierten Weichteil- und Knochendeformitäten. *Kleintierpraxis* 42: 953-964.
8. Koch D. A., Grundmann S., Savoldelli D., L'Eplattenier H., Montavon P. M. (1998): Die Diagnostik der Patellaluxation des Kleintieres. *Schweiz. Arch. Tierheilk.* 140: 371-374.
9. Kowaleski M. P., Boudrieau R. J., Pozzi A. (2012): Stifle Joint. *Veterinary Surgery Small Animal*. Tobias K. M. and Johnston S. A. St. Louis, Elsevier: 906-998.
10. Lehmann S. V., Andrada E., Taszus R., Koch D. A., Fischer M. S. (2020): Three-dimensional motion of the patella in French bulldogs with and without medial patellar luxation. *BMC Vet Res*: submitted.
11. OFA. (2020). "<https://www.ofa.org/diseases/other-diseases/patellar-luxation>."
12. Petazzoni M. (2015): *Surgical Treatment of Medial Patellar Luxation in Dogs using Tibial Tuberosity Transposition Tool*. SCIVAC International Congress, Rimini.
13. Putnam R. W. (1968). *Patellar luxation in the dog Type, Thesis, University of Guelph, Ontario, Thesis*.
14. Schwarz G. (2005): *Fractures of the proximal tibia. AO Principles of Fracture Management in the Dog and Cat*. Stuttgart, Thieme: 311-318.
15. Singleton W. B. (1969): *The surgical correction of stifle deformities in the dog. J Small Anim Pract* 10: 59-69.
16. Slocum B., Devine T. (1985): *Trochlear recession for correction of luxating patella in the dog. J Am Vet Med Assoc* 186: 365-369.

## EICKLOXX SPP® PATELLAR LUXATION SYSTEM – SPECIALIST ARTICLE

---

17. Vidoni B., Sommerfeld-Stur I., Eisenmenger E. (2005): Diagnostische und züchterische Aspekte der Patellaluxation bei Klein- und Zwerghunderassen in Österreich. Vienna. Tierärztl. Mschr. 92: 170-181.

18. Weber U. (1992). Morphologische Studie am Becken von Papillon-Hunden unter Berücksichtigung von Faktoren zur Ätiologie der nicht-traumatischen Patellaluxation nach medial. Dissertation, University of Zurich.

Published in a similar form in the magazine KLEINTIERMEDIZIN, Issue 2-2021, pp. 6–10

© Copyright – text and photos by the author



### **Dr. Daniel Koch**

*Specialist in small animal surgery; DECVS*

Specialist in small animal surgery; DECVS; Specialisations: joint surgery, osteosynthesis, airway obstruction and dental treatment; Research areas: brachycephalic syndrome, knee joint of the dog.

## EICKLOXX SPP® PATELLAR LUXATION SYSTEM – VIDEO

---

**EickLoxx SPP® application video**



# PRACTICE FURNITURE

## Low Lift Scissor Table

*Perfect for lifting & transporting larger patients without unnecessary handling*

*8 different  
colours*

*Various  
add-ons*



GO **ONLINE** NOW TO FIND OUT MORE

[www.eickemeyer.com/practice-furniture/examination-transportation-tables](http://www.eickemeyer.com/practice-furniture/examination-transportation-tables)



# 3M™ IOBAN™ 2

Incision Drape for small animals up to 80 kg



# 3M™ IOBAN™ 2 INCISION DRAPE – COMPONENTS AND CHARACTERISTICS

**A sterile operating field during the surgical procedure – reduced post-operative wound infection**

**These are Ioban™ incision drapes**

The Ioban™ antimicrobial incision drapes are designed to reduce the risk of post-operative wound infection. They are applied to the patient's skin at the incision site to create a sterile surgical field and to produce an antimicrobial effect during the surgical procedure. Ioban™ is an adhesive incision drape, impregnated with iodophor, that forms a barrier and a spectrum of antimicrobial activity on the patient's skin flora.

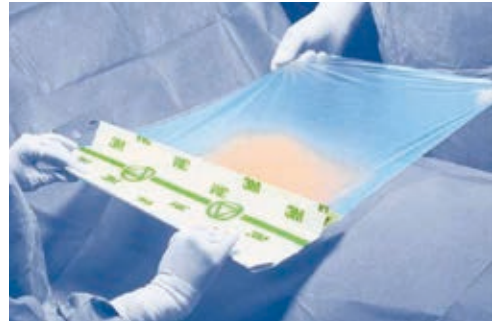

## Size 1

- ▶ Adhesive area (in cm):  
L 10 x W 20
- ▶ Dimensions (in cm):  
L 15 x W 20
- ▶ 10 per pack

**191600**

## Size 2

- ▶ Adhesive area (in cm):  
L 35 x W 35
- ▶ Dimensions (in cm):  
L 60 x W 35
- ▶ 10 per pack

**191601**

## Strong adhesive and antimicrobial effect

3M™ Ioban™ 2 Antimicrobial incision drapes adhere securely to the skin, reducing the risk of the drape peeling off. (Drapes which peel off during surgery can lead to a six-fold increase in post-operative wound infections.) The adhesive, impregnated with iodophor, in an Ioban™ incision drape offers a broad, continuously effective spectrum of antimicrobial effects to the edges of the drape and reduces the risk of wound contamination.

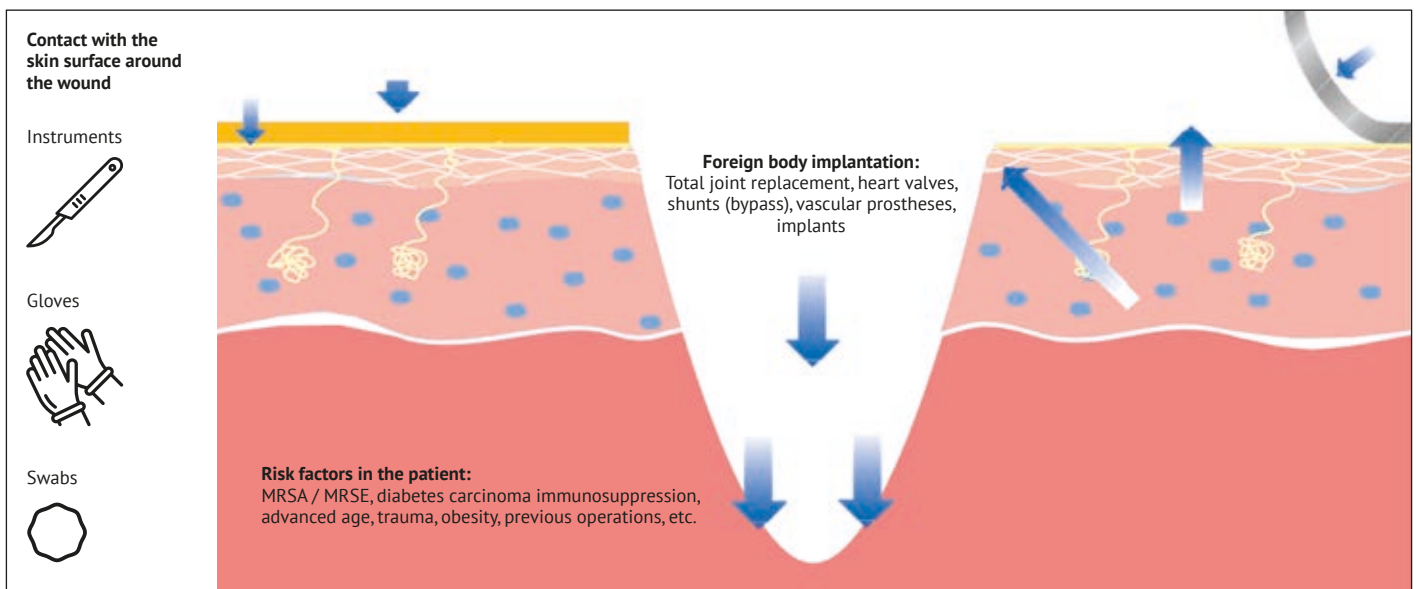

## An efficient bacterial barrier – 3M™ Ioban™ 2

- ▶ Forms a barrier and reduces the risk of bacteria entering the surgical wound
- ▶ Ensures constant contact with the patient's skin – even when using fluids to rinse
- ▶ Offers a continuously broad spectrum of antimicrobial activity to the edge of the wound
- ▶ Adheres securely to the skin to prevent the drape from peeling off and the skin antiseptic from being washed off
- ▶ Flexible film adapts to body contours and allows manipulation of the limbs
- ▶ Breathable and latex-free incision drape

# 3M™ IOBAN™ 2 INCISION DRAPE – APPLICATION

## Application

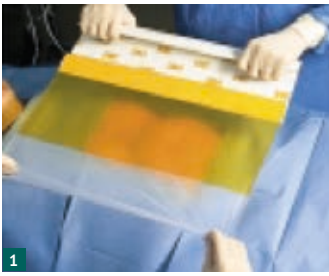

Step 1: Disinfect the skin with your usual skin-preparation. Allow the skin-preparation agent to dry completely.

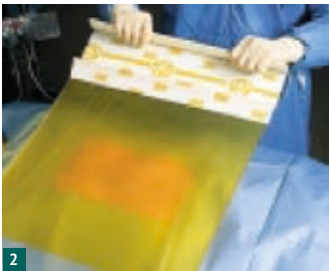

Step 2: With the assistance of a colleague, remove the liner on the 3M™ incise drape until the  appears.



Step 3: Hold the drape over the intended incision site with adequate tension but without overstretching.



Step 4: Smooth the drape first along the intended incision line with a sterile towel.



Step 5: Working away from the incision line, smooth the remainder of the drape into place.

## Removal

### Prior to skin closure



Step 1: Create a crease in the drape by pinching the film near the incision's edge.



Step 2: Pull up on crease, separating the drape from the skin at the incision's edge, exposing up to three centimetres of skin surface. Proceed with closure.

### After skin closure



Step 3: Before removing the drape, first cover the incision with the dressing.



Step 4: Remove the fabric drape with the film attached by folding the drape/towel 180° back on itself. Pull gently with even tension. **Do not pull up.** To remove incision drapes from reusable linen drapes or towels, wet the material and then peel the incision drape off the material.

3M™ Ioban™ brand names are the worldwide trademarks or registered trademarks of 3M.

# ENDOSCOPY

## EickView 150

*The perfect solution for video gastroscopy  
in dogs and cats*

*Brilliant  
images*

*Various  
scope-sizes*



GO **ONLINE** NOW TO FIND OUT MORE

[www.eickemeyer.com/endoscopy/broncho-gastroscopy](http://www.eickemeyer.com/endoscopy/broncho-gastroscopy)

# OrthoVet PLUS

Battery Drill System



## ORTHOVET PLUS BATTERY DRILL SYSTEM – COMPONENTS

The OrthoVet PLUS is a battery driven drill system designed for small animal surgery for use in the entire spectrum of veterinary osteosynthesis. Modular, handy, wireless, it is ideal for use in treating small animal osteosynthesis.

The handpiece (item no. 195077) and 4 attachments can be interchanged by the keyless quick coupling within seconds; this also applies to the saw blades when used for drilling, reaming, or cutting bone.

The OrthoVet PLUS can be operated in both the right and left direction, as well as in oscillation cutting mode with the saw attachment.

The handpiece and the two quick-coupling attachments, the one for K-Wires/STEINMANN nails (item no. 195079) and the Jacobs Drill Chuck attachment (item no. 195078) are cannulated. Thus, cannulated screws or cannulated tools such as drills can be guided over long K-Wires stepwise, without shortening the K-Wire.

The Oscillating Saw Attachment (item no. 195081) and the AO Quick Chuck Attachment for AO tools (item no. 195080) enable rapid changes not only during surgical use, but in the exchange of various drill sizes, cutters, taps and keyless saw blades.



195077

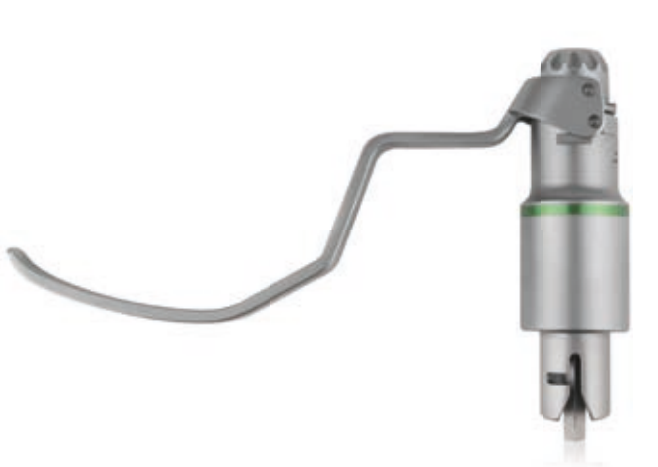

195079



195078



195080



195081

## ORTHOVET PLUS BATTERY DRILL SYSTEM – CHARACTERISTICS

---

A 5-fold variable fixation of the saw blade in its fitting allows the surgeon an optimised view of the surgical field (Fig. 1).

The OrthoVet PLUS battery drill system can be instantly operated by means of the “trigger” on the handpiece, speeds of 0–1,200 rpm or 0–1,800 osc./min.

Handpiece and attachments can be sterilised / autoclaved. For this purpose a washer compatible sterilisation tray (item no. 195086) as well as a suitable sterilisation container (item no. 185555) are optionally available.

The battery (item no. 195083) must not be sterilised/autoclaved! It is inserted into the handpiece via a funnel.

For details on handling and construction, refer to the operating instructions.



Figure 1



185555

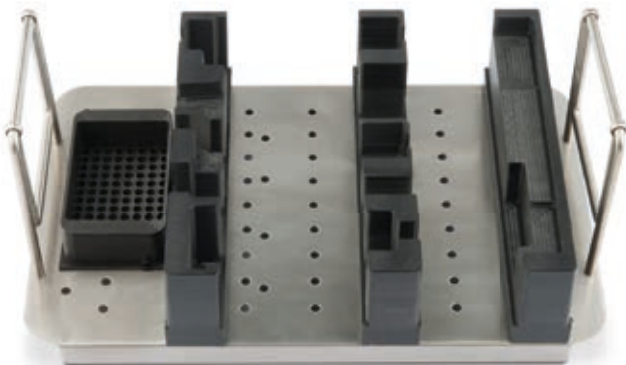

195086

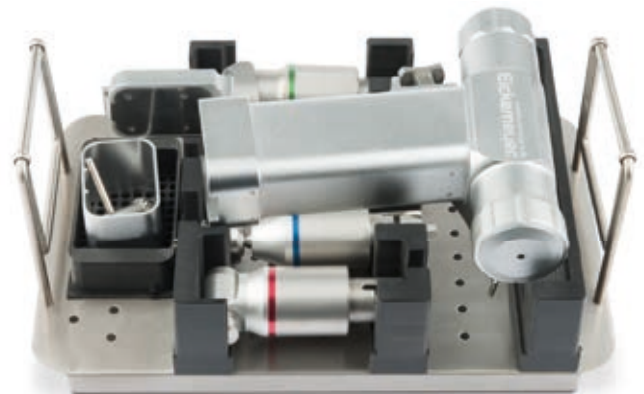

Application

## ORTHOVET PLUS BATTERY DRILL SYSTEM – ITEM LIST

OrthoVet PLUS Battery Drill System		
Item No.	Description	Quantity
195070	OrthoVet PLUS Battery Drill System, consisting of:	
195077	OrthoVet PLUS Handpiece, without adapters and battery	1
195078	OrthoVet PLUS Jacobs Chuck Adapter	1
195079	OrthoVet PLUS Quick Coupling Adapter for Pins/K-Wires, Ø 0.8 – 2.6 mm	1
195080	OrthoVet PLUS Quick Coupling Adapter for AO Tools	1
195081	OrthoVet PLUS Oscillating Saw Adapter	1
195082	OrthoVet PLUS Battery Charging Station	1
195083	OrthoVet PLUS Battery	2
195084	OrthoVet PLUS Key to Jacobs Chuck Adapter	1
195085	OrthoVet PLUS Funnel for Handpiece	1
195088	OrthoVet PLUS Transportation Case, metal, dimensions (in mm): L 390 x W 290 x H 120	1
196130	Saw Blade, AESCULAP connection, dimensions (in mm): L 50 x W 6.5 x H 0.4	1
196140	Saw Blade, AESCULAP connection, dimensions (in mm): L 50 x W 8 x H 0.4	1
196150	Saw Blade, AESCULAP connection, dimensions (in mm): L 45 x W 10 x H 0.5	1
196160	Saw Blade, AESCULAP connection, dimensions (in mm): L 36 x W 12 x H 0.5	1

Optional Accessories		
Item No.	Description	Quantity
196170	Saw Blade, AESCULAP connection, dimensions (in mm): L 58 x W 10 x H 0.5	1
196180	Saw Blade, AESCULAP connection, dimensions (in mm): L 64 x W 10 x H 0.5	1
196190	Saw Blade, AESCULAP connection, dimensions (in mm): L 70 x W 14 x H 0.5	1
195086	Sterilisation Tray for OrthoVet PLUS, empty	1
185555	Container, bottom non-perforated, lid perforated, silver, dimensions (in mm): L 312 x W 183 x H 122	1



# OrthoVet TPL0

Battery Saw



# ORTHOVET TPLO BATTERY SAW – CHARACTERISTICS AND COMPONENTS

The OrthoVet TPLO Battery Saw is an oscillating saw designed for use in small animal surgery for precise cuts in Tibial Plateau Leveling Osteotomy (TPLO).

The rod-shaped, ergonomic design of the handpiece allows a powerful, low vibration, with a fast and precise semi-circular cut through the tibial head. The battery-powered high-performance motor can be smoothly adjusted to 16,000 oscillations per minute.

The OrthoVet TPLO Battery Saw is equipped with a triangular standard coupling. Seven saw blades ranging from 12 mm to 30 mm are fixed by simply screwing them with an ALLEN key. The thin saw blades provide excellent cutting performance with minimal bone loss, and the cutting thickness is only 0.6 mm.

## Advantages

- ▶ Maximum power with low vibration
- ▶ Powerful (90 watt)
- ▶ Ergonomic design and easy handling
- ▶ Smooth speed control
- ▶ Reliable and long-lasting NiMH battery

The OrthoVet TPLO Battery Saw Set (item no. 195071) consists of:

- ▶ Handpiece including ALLEN key SW 2.5 (item no. 195072)
- ▶ Battery Charging Station (item no. 195073)
- ▶ Two Batteries (item no. 195074)
- ▶ Transport Case (item no. 195075)
- ▶ Two Funnels for Handpiece (item no. 195076)

Handpiece and funnel can be sterilised/autoclaved. The battery must not be sterilised/autoclaved. It is inserted into the handpiece via a funnel.

For details on handling and reprocessing, refer to the user manual.

Technical Data	
Continuously adjustable speed	0–16,000 osc./min.
Length; Diameter	290 mm, 55 mm
Weight (with battery)	1,360 g
Battery alone	290 g
Operating voltage	9.6 VDC
Battery capacity	1.2 Ah
Battery type	NiMH
Empty battery charging time	max. 180 min
Degree of protection against electrical shock	B
Degree of protection against the penetration of water	IPX4
Noise level in operating position (with chuck Item no. 195079)	about 75 dB(A)

Technical data is subject to tolerances. Specifications are approximate and may vary from one device to another or because of power supply fluctuations.



195071

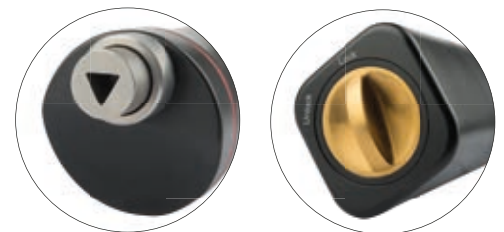

195072

## ORTHOVET TPLO BATTERY SAW – ITEM LIST

OrthoVet TPLO Battery Saw		
Item No.	Description	Quantity
195071	OrthoVet TPLO Battery Saw, consisting of:	
195072	OrthoVet TPLO Handpiece, with key, without battery	1
195073	OrthoVet TPLO Charging Station	1
195074	OrthoVet TPLO Battery	2
195075	OrthoVet TPLO Transportation Case, metal, dimensions (in mm): L 390 x W 320 x H 140	1
195076	OrthoVet TPLO Funnel for Handpiece	2

Optional Accessories		
Item No.	Description	Quantity
192907	TPLO Saw Blade, non-cannulated, triangular shaft, R 12 x L 45 mm	1
192908	TPLO Saw Blade, non-cannulated, triangular shaft, R 15 x L 45 mm	1
192909	TPLO Saw Blade, non-cannulated, triangular shaft, R 18 x L 45 mm	1
192912	TPLO Saw Blade, non-cannulated, triangular shaft, R 21 x L 45 mm	1
192910	TPLO Saw Blade, non-cannulated, triangular shaft, R 24 x L 45 mm	1
191913	TPLO Saw Blade, non-cannulated, triangular shaft, R 27 x L 50 mm	1
192911	TPLO Saw Blade, non-cannulated, triangular shaft, R 30 x L 50 mm	1
192851	TPLO Saw Blade, cannulated, triangular shaft, R 9 x L 45 mm	1
192852	TPLO Saw Blade, cannulated, triangular shaft, R 12 x L 45 mm	1
192853	TPLO Saw Blade, cannulated, triangular shaft, R 15 x L 45 mm	1
192854	TPLO Saw Blade, cannulated, triangular shaft, R 18 x L 45 mm	1
192855	TPLO Saw Blade, cannulated, triangular shaft, R 21 x L 45 mm	1
192856	TPLO Saw Blade, cannulated, triangular shaft, R 24 x L 45 mm	1
192857	TPLO Saw Blade, cannulated, triangular shaft, R 27 x L 50 mm	1
192858	TPLO Saw Blade, cannulated, triangular shaft, R 30 x L 50 mm	1
192859	TPLO Saw Blade, cannulated, triangular shaft, R 33 x L 50 mm	1

EICKEMEYER KG  
Eltastraße 8  
78532 Tuttlingen  
Germany  
T +49 7461 96 580 0  
F +49 7461 96 580 90  
export@eickemeyer.com  
www.eickemeyer.com

EICKEMEYER AG  
Sandgrube 29  
9050 Appenzell  
Schweiz  
T 071 788 23 13  
F 071 788 23 14  
info@eickemeyer.ch  
www.eickemeyer.ch

EICKEMEYER S.R.L.  
Via G. Verdi 8  
65015 Montesilvano (PE)  
Italia  
T 085 935 4078  
F 085 935 9471  
info@eickemeyer.it  
www.eickemeyer.it

EICKEMEYER Sp. z o.o.  
Al. Jana Pawła II 27  
00-867 Warszawa  
Polska  
T 22 185 55 76  
F 22 185 59 40  
info@eickemeyer.pl  
www.eickemeyer.pl

EICKEMEYER B.V.  
Bellweg 44  
4104 BJ Culemborg  
Nederland  
T +31 345 58 9400  
info@eickemeyer.nl  
www.eickemeyer.nl

EICKEMEYER ApS  
Solbakken 26, Hammelev  
6500 Vojens  
Danmark  
T +45 7020 5019  
info@eickemeyer.dk  
www.eickemeyer.dk

EICKEMEYER Inc.  
617 Douro Street, Suite #205  
Stratford, Ont. Canada  
N5A 0B5  
T +1 519 273 5558  
F +1 519 271 7114  
info@eickemeyervet.ca  
www.eickemeyercanada.ca

EICKEMEYER Ltd.  
3 Windmill Business Village  
Brooklands Close  
Sunbury-on-Thames  
Surrey | TW16 7DY  
United Kingdom  
T 020 8891 2007  
info@eickemeyer.co.uk  
www.eickemeyer.co.uk